

Aston Switch 20W

technical lighting

4439, 4440

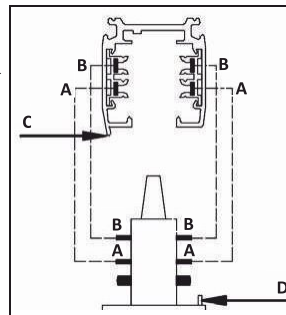
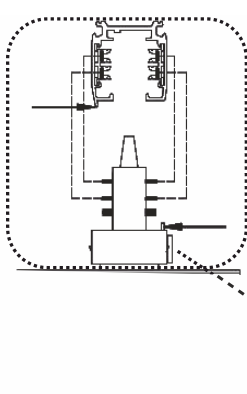
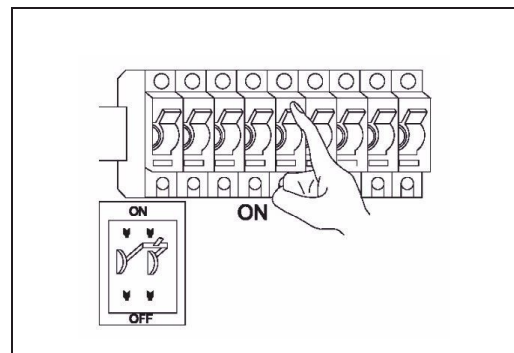
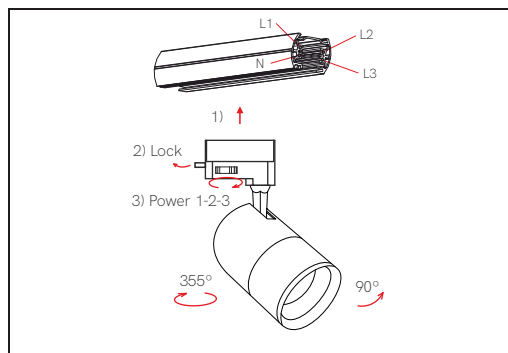
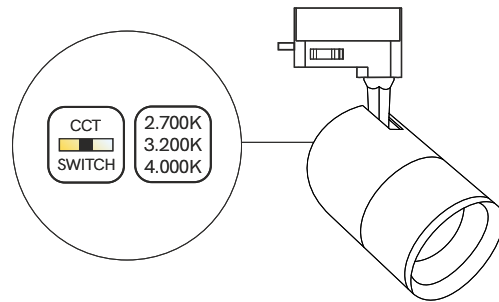
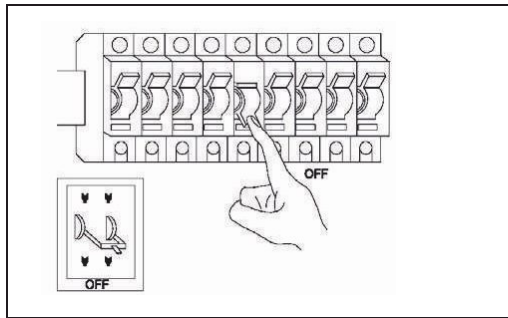

In order to match the A and B both track adapter and track.
Please pay attention C point and D point must be on the opposite direction.



Danger !

Installation by electricians only

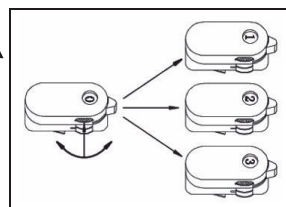

Four line three circuit for track adapter.
Select the circuit position.
"0" circuit: No Power, No electricity.
"1" circuit: Power on for circuit "1".
"2" circuit: Power on for circuit "2".
"3" circuit: Power on for circuit "3".

CE RoHS  

>0,9 PF	≥80 CRI	15° 38° 60°	CCT SWITCH	2.700K 3.200K 4.000K	2.400 Lm	3 YEARS WARRANTY
220/240 VAC	50/60 Hz	+50°C -20°C		20 IP	30.000 HOURS	UGR <19