

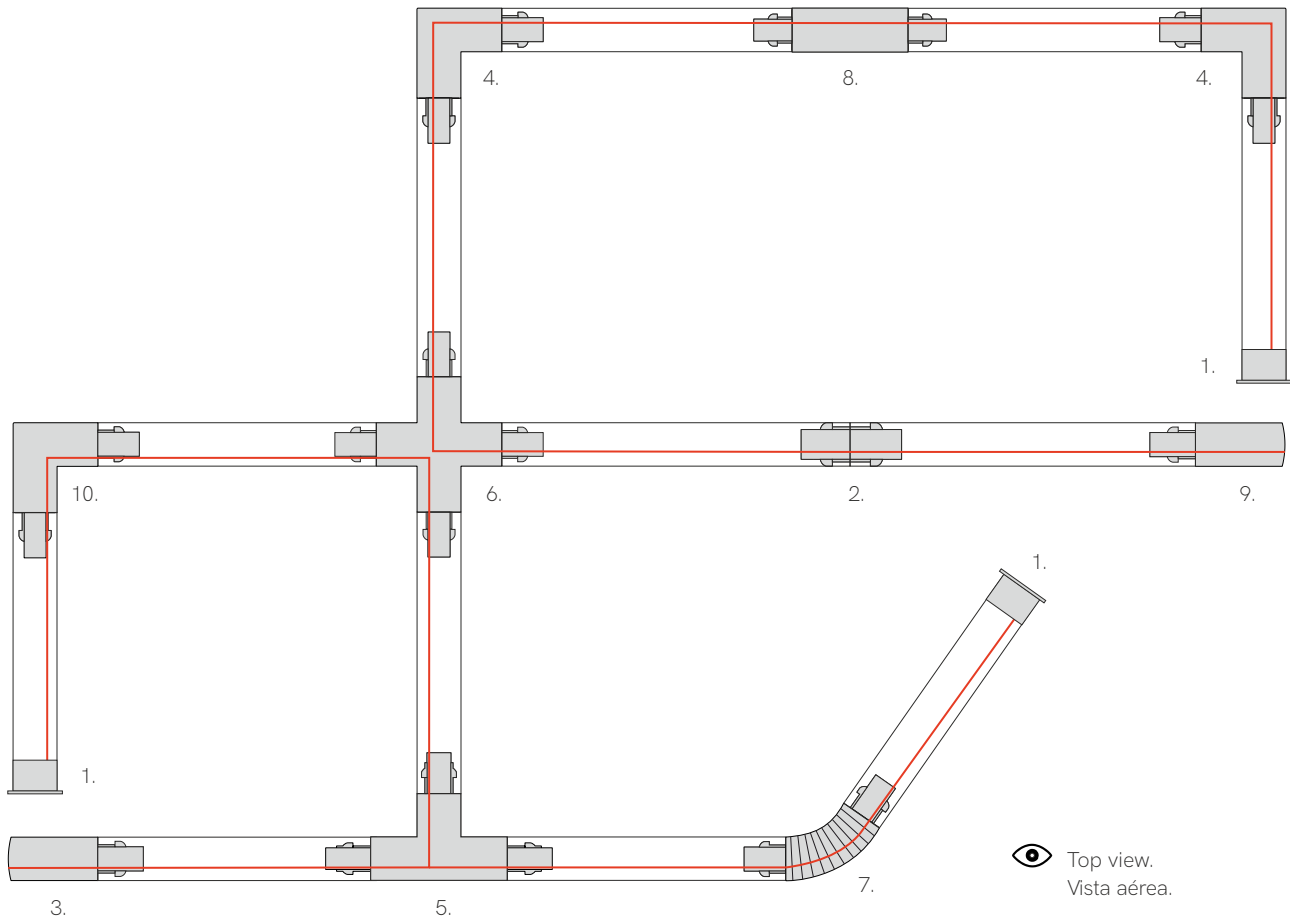

Three phase track

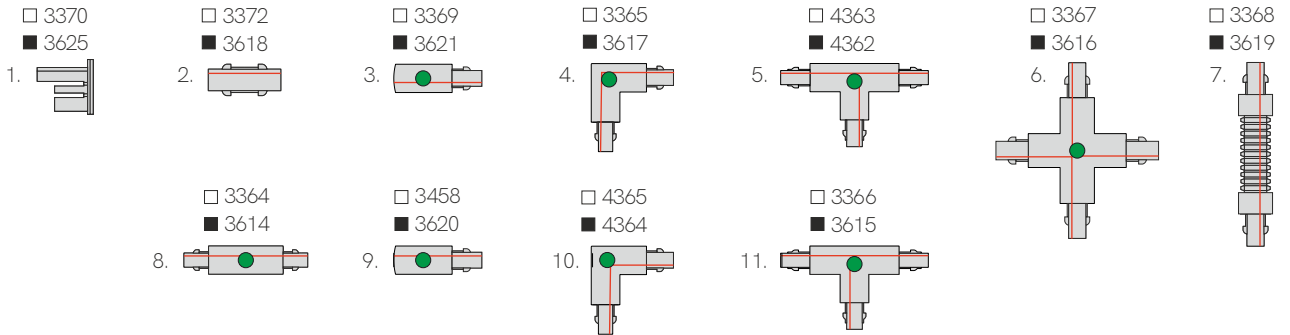

Three phase track surface accessories



● Allows power input

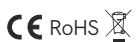

3 YEARS WARRANTY | IP 20



Three phase track surface

L: 32mm W: 31mm H: 31mm

1m 3795

2m 3796

3m 3797

1m D-3626

2m D-3627

3m D-3628

*End cap and right power connector included



Ceiling fixing 3PH surface

L: 30mm W: 25mm H: 12mm

3373

3623



Power connector 3PH surface

L: 98mm W: 32mm H: 32mm

Left 3369

Right 3458

Left 3621

Right 3620



Linear joint 3PH without spacing

L: 68mm W: 25mm H: 27mm

3372

3618



Linear joint 3PH with spacing surface

L: 166mm W: 35mm H: 32mm

3364

3614



L joint 90° 3PH surface

L: 100mm W: 66mm H: 32mm

Left 4365

Right 3365

Left 4364

Right 3617



T joint 3PH surface

L: 166mm W: 100mm H: 32mm

Left 4363

Right 3366

Left 4362

Right 3615

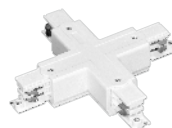

X joint 3PH surface

L: 166mm W: 166mm H: 32mm

3367

3616



Flexible joint 3PH

L: 245mm W: 35mm H: 32mm

3368

3619



End cap 3PH

L: 32mm W: 32mm H: 32mm

3370

3625



Adapter 3PH

L: 70mm W: 40mm H: 41mm

3371-V2

3624-V2



Suspension kit 3PH

L: 3.000mm W: Ø35 | Ø2.4 H: 47mm

3459

3622



Surface base 3PH

L: Ø100mm H: 32mm

4700

4701

Surface



Common



Base



Three phase track recessed accessories

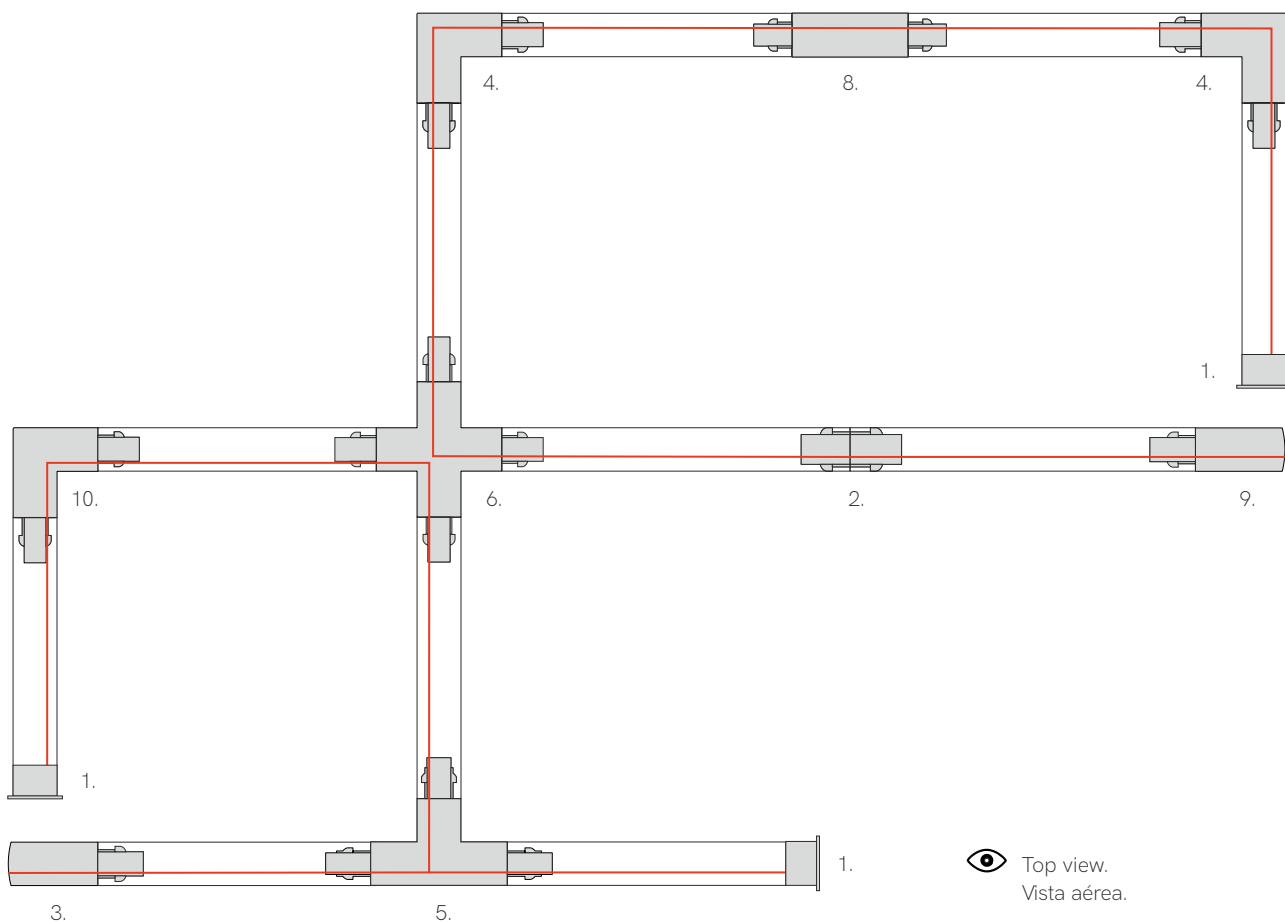
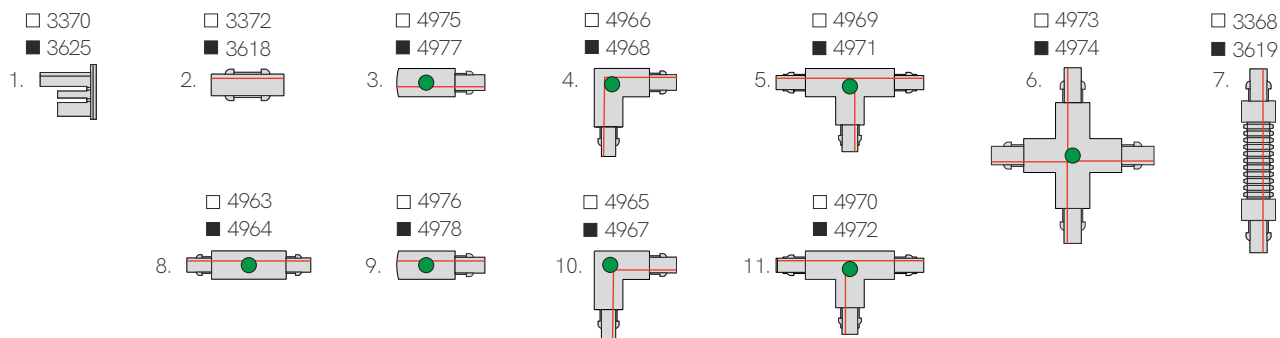

● Allows power input

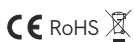

3 YEARS WARRANTY | IP 20



*End cap and right power connector included

Three phase track recessed

W: 56mm H: 33mm

- 2m 3897
- 3m 3898
- 2m 4753
- 3m 4754



Ceiling fixing 3PH recessed

L: 64mm W: 25mm H: 32mm

- 3805



Power connector 3PH recessed

L: 98mm W: 56,5mm H: 33,7mm

- Left 4975
- Right 4976
- Left 4977
- Right 4978



Linear joint 3PH without spacing

L: 68mm W: 25mm H: 27mm

- 3372
- 3618



Linear joint 3PH with spacing recessed

L: 166mm W: 56,5mm H: 33,7mm

- 4963
- 4964



Flexible joint 3PH

L: 245mm W: 35mm H: 32mm

- 3368
- 3619



L joint 3PH recessed

L: 111mm W: 111mm H: 33,7mm

- Left 4965
- Right 4966
- Left 4967
- Right 4968

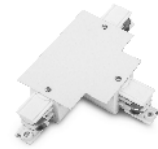

T joint 3PH recessed

L: 166mm W: 111mm H: 33,7mm

- Left 4969
- Right 4970
- Left 4971
- Right 4972



X joint 3PH recessed

L: 166mm W: 166mm H: 33,7mm

- 4973
- 4974



End cap 3PH

L: 32mm W: 32mm H: 32mm

- 3370
- 3625



Adapter 3PH

L: 70mm W: 40mm H: 41mm

- 3371-V2
- 3624-V2



Recessed base 3PH

L: Ø130mm H: 60mm Ø110mm

- 3851
- 3852

*Need Three Phase Surface Base (4700 or 4701) to put inside.

Recessed



Common



Base



New

Nano Alp 3PH suspension

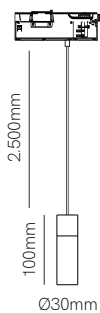

Alp 3PH suspension

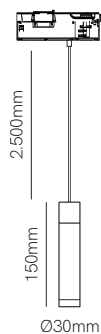

Technical Information

Power	5W	5W
Installation	Three Phase Track	Three Phase Track
Color Temperature	Switch 2.700K / 3.200K / 4.000K	Switch 2.700K / 3.200K / 4.000K
Lumens	370 lm	370 lm
Material	Aluminium	Aluminium
Finishes	White / Black	White / Black
Code	<input type="radio"/> 190S11 ON/OFF <input checked="" type="radio"/> 190S12 ON/OFF <input type="radio"/> 190S41 TRIAC <input checked="" type="radio"/> 190S42 TRIAC	<input type="radio"/> 191S11 ON/OFF <input checked="" type="radio"/> 191S12 ON/OFF <input type="radio"/> 191S41 TRIAC <input checked="" type="radio"/> 191S42 TRIAC

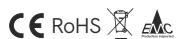

ⓘ Consult delivery terms and conditions.

3 YEARS WARRANTY | 30.000 HOURS | IP 20 | 220/240 VAC | UGR <19 | PF >0,9 | CRI ≥93 | □ | 45° ▲ | 50/60 Hz | 🌡️ +45°C / -20°C | CCT SWITCH | 1/60

New

Ark 3PH suspension

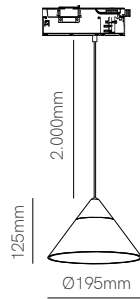

TRACK LIGHTS

Technical Information

Power	6W
Installation	Three Phase Track
Color Temperature	2.700K / 3.000K
Lumens	350 lm / 360 lm
Material	Aluminium and acrylic
Finishes	White-transparent / Black-transparent / Black-gray

Code	198211	ON/ OFF		White-transp. 2.700K	199241	TRIAC		White-transp. 2.700K
	198311	ON/ OFF		White-transp. 3.000K	199341	TRIAC		White-transp. 3.000K
	198212	ON/ OFF		Black-transp. 2.700K	199242	TRIAC		Black-transp. 2.700K
	198312	ON/ OFF		Black-transp. 3.000K	199342	TRIAC		Black-transp. 3.000K
	198219	ON/ OFF		Black-gray 2.700K	199249	TRIAC		Black-gray 2.700K
	198319	ON/ OFF		Black-gray 3.000K	199349	TRIAC		Black-gray 3.000K



3 YEARS WARRANTY | 26.000 HOURS | → | IP 20 | 220/240 VAC | UGR <19 | PF >0,9 | | | 50/60 Hz | +40°C / -20°C |

New

Atmos 3PH suspension

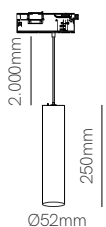

Atmos XL 3PH suspension

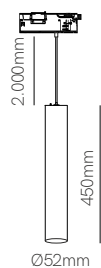

Technical Information

Power	7W	10W
Installation	Three Phase Track	Three Phase Track
Color Temperature	Switch 2.700K / 3.200K / 4.000K	Switch 2.700K / 3.200K / 4.000K
Lumens	770 lm	1.100 lm
Material	Aluminium	Aluminium
Finishes	White / Black	White / Black
Code	<input type="radio"/> 313S11 ON/OFF <input checked="" type="radio"/> 313S12 ON/OFF <input type="radio"/> 313S41 TRIAC <input checked="" type="radio"/> 313S42 TRIAC	<input type="radio"/> 314S11 ON/OFF <input checked="" type="radio"/> 314S12 ON/OFF <input type="radio"/> 314S41 TRIAC <input checked="" type="radio"/> 314S42 TRIAC



ⓘ Consult delivery terms and conditions.

Accessories



Included with:
313S11 / 313S41 / 314S11 / 314S41



Included with:
313S12 / 313S42 / 314S12 / 314S42

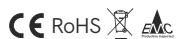

3 YEARS WARRANTY | 30.000 HOURS | IP 20 | 220/240 VAC | UGR <19 | PF >0,9 | CRI ≥90 | 15° 38° 60° | 50/60 Hz | +50°C -20°C | CCT SWITCH

New

Atmos GU10 3PH suspension



Atmos GU10 XL 3PH suspension

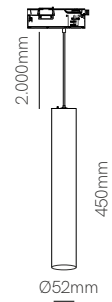
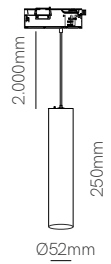

Technical Information

Installation	Three Phase Track	Three Phase Track
Material	Aluminium	Aluminium
Finishes	White / Black / Chrome	White / Black / Chrome
Bulbholder	50mm GU10 (except Power bulb)	50mm GU10 (except Power bulb)
Code	<input type="radio"/> 315011 <input checked="" type="radio"/> 315012	<input type="radio"/> 316011 <input checked="" type="radio"/> 316012

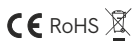

ⓘ Consult delivery terms and conditions.

3 YEARS WARRANTY | IP 20 | 220/240 VAC |

New

Bora 3PH suspension



Bora XL 3PH suspension

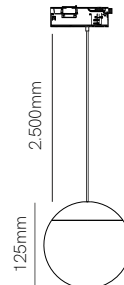

Technical Information

Power	8W	15W
Installation	Three Phase Track	Three Phase Track
Color Temperature	Switch 2.700K / 3.200K / 4.000K	Switch 2.700K / 3.200K / 4.000K
Lumens	570 lm	1.100 lm
Material	Aluminium	Aluminium
Finishes	White / Black	White / Black

Code	<input type="radio"/> 192S11 ON/OFF	<input type="radio"/> 193S11 ON/OFF
	<input checked="" type="radio"/> 192S12 ON/OFF	<input checked="" type="radio"/> 193S12 ON/OFF
	<input type="radio"/> 192S41 TRIAC	<input type="radio"/> 193S41 TRIAC
	<input checked="" type="radio"/> 192S42 TRIAC	<input checked="" type="radio"/> 193S42 TRIAC

1/30

1/20



ⓘ Consult delivery terms and conditions.

3 YEARS WARRANTY | 30.000 HOURS | IP 20 | 220/240 VAC | UGR <19 | PF >0,9 | CRI ≥93 | 38° | 50/60 Hz | +45°C / -20°C | CCT SWITCH

New

Lievo 3PH suspension

Lievo XL 3PH suspension

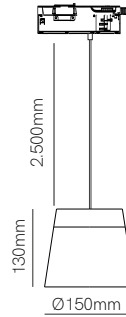
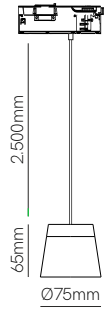

TRACK LIGHTS

Technical Information

Power	8W	15W
Installation	Three Phase Track	Three Phase Track
Color Temperature	Switch 2.700K / 3.200K / 4.000K	Switch 2.700K / 3.200K / 4.000K
Lumens	570 lm	1.100 lm
Material	Aluminium	Aluminium
Finishes	White / Black	White / Black
V / I in	20-55VDC/150mA	20-42VDC/350mA

Code	<input type="radio"/> 194S11 ON/OFF	<input type="radio"/> 195S11 ON/OFF
	<input checked="" type="radio"/> 194S12 ON/OFF	<input checked="" type="radio"/> 195S12 ON/OFF
	<input type="radio"/> 194S41 TRIAC	<input type="radio"/> 195S41 TRIAC
	<input checked="" type="radio"/> 192S42 TRIAC	<input checked="" type="radio"/> 195S42 TRIAC



ⓘ Consult delivery terms and conditions.

3 YEARS WARRANTY | 30.000 HOURS | IP 20 | 220/240 VAC | UGR <19 | PF >0,9 | CRI ≥93 | 38° | 50/60 Hz | +45°C / -20°C | CCT SWITCH



▶ VIDEO



New

Zoe 3PH suspension

Zoe XL 3PH suspension

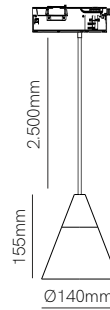
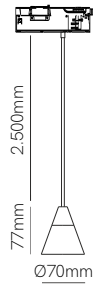

Technical Information

Power	8W	15W
Installation	Three Phase Track	Three Phase Track
Color Temperature	Switch 2.700K / 3.200K / 4.000K	Switch 2.700K / 3.200K / 4.000K
Lumens	570 lm	1.100 lm
Material	Aluminium	Aluminium
Finishes	White / Black	White / Black

Code	△ 196S11 ON/OFF	△ 197S11 ON/OFF
	▲ 196S12 ON/OFF	▲ 197S12 ON/OFF
	△ 196S41 TRIAC	△ 197S41 TRIAC
	▲ 196S42 TRIAC	▲ 197S42 TRIAC

1/30

1/12



ⓘ Consult delivery terms and conditions.

3 YEARS WARRANTY | 30.000 HOURS | IP 20 | 220/240 VAC | UGR <19 | PF >0,9 | CRI ≥93 | 38° | 50/60 Hz | +45°C / -20°C | CCT SWITCH

New

Mini Hat 3PH suspension

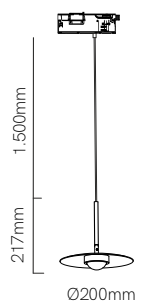

Hat 3PH suspension

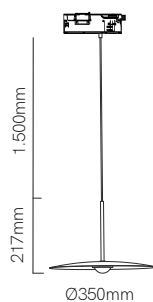

Technical Information

Power	8W	8W
Installation	Three Phase Track	Three Phase Track
Color Temperature	2.700K / 3.000K	2.700K / 3.000K
Lumens	800lm	835 lm
Material	Aluminium	Aluminium
Finishes	White / Black	White / Black

Code	○ 2.700K ON/OFF	311211	○ 2.700K ON/OFF	312211
	○ 3.000K ON/OFF	311311	○ 3.000K ON/OFF	312311
	● 2.700K ON/OFF	311212	● 2.700K ON/OFF	312212
	● 3.000K ON/OFF	311312	● 3.000K ON/OFF	312312
	○ 2.700K TRIAC	311241	○ 2.700K TRIAC	312241
	○ 3.000K TRIAC	311341	○ 3.000K TRIAC	312341
	● 2.700K TRIAC	311242	● 2.700K TRIAC	312242
	● 3.000K TRIAC	311342	● 3.000K TRIAC	312342

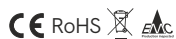

3 YEARS WARRANTY | 30.000 HOURS | → | IP 20 | 220/240 VAC | PF >0,9 | CRI ≥90 | | 50/60 Hz | +40°C / -20°C

New

Cookie 3PH suspension

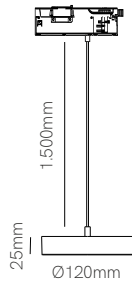

Technical Information

Power	12W
Installation	Three Phase Track
Color Temperature	Switch 2.700K / 3.200K / 4.000K
Lumens	985 lm
Material	Aluminium
Finishes	White / Black

Code	<input type="radio"/> 310S11 ON/OFF <input checked="" type="radio"/> 310S12 ON /OFF <input type="radio"/> 310S41 TRIAC <input checked="" type="radio"/> 310S42 TRIAC
------	---



ⓘ Consult delivery terms and conditions.

3 YEARS WARRANTY | 30.000 HOURS | IP 20 | 2220/240 VAC | UGR <19 | PF >0,9 | CRI ≥90 | 38° | 50/60 Hz | TRIAC DIMM | +40°C / -20°C | CCT SWITCH | 1/20

New

Sphere 3PH suspension

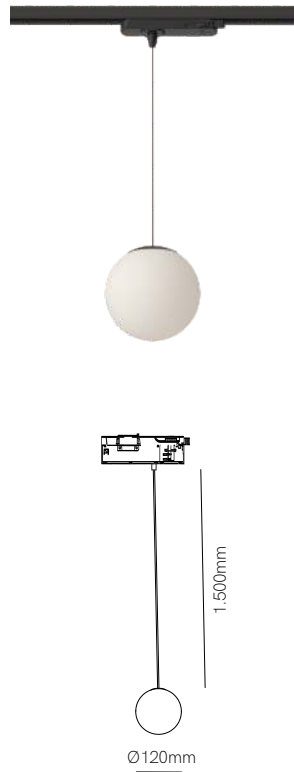

Technical Information

Power	8W
Installation	Three Phase Track
Color Temperature	2.700K / 3.000K
Lumens	255 lm
Material	Aluminium and glass
Finishes	White / Black

Code	<input type="radio"/>	2.700K ON/OFF	317211
	<input type="radio"/>	3.000K ON/OFF	317311
	<input checked="" type="radio"/>	2.700K ON/OFF	317212
	<input checked="" type="radio"/>	3.000K ON/OFF	317312
	<input type="radio"/>	2.700K TRIAC	317241
	<input type="radio"/>	3.000K TRIAC	317341
	<input checked="" type="radio"/>	2.700K TRIAC	317242
	<input checked="" type="radio"/>	3.000K TRIAC	317342



3 YEARS WARRANTY | 30.000 HOURS | → | IP 20 | 220/240 VAC | UGR <19 | | | 360° | +40°C / -20°C | 1/12

Piccolo 3PH



Technical Information

Power	9,5W
Installation	Three Phase Track
Color Temperature	Switch 2.700K / 3.200K / 4.000K
Lumens	1.300 lm
Material	Aluminium
Finishes	White / Black

Code	<input type="radio"/> 4437-N <input type="radio"/> 4438-N <input checked="" type="radio"/> Custom RAL
------	---



ⓘ Consult delivery terms and conditions.

3 YEARS WARRANTY | 30.000 HOURS | IP 20 | 220/240 VAC | UGR <19 | PF >0,9 | CRI ≥90 | ⚡ | 15° 38° 60° | 50/60 Hz | +50°C -20°C | CCT SWITCH | 1/20



Piccolo GU10 3PH



Piccolo AR111 3PH

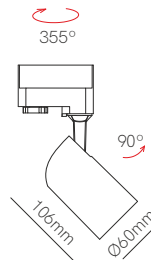
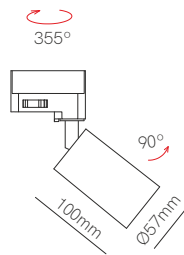

Technical Information

Installation	Three Phase Track	Three Phase Track
Material	Aluminium	Aluminium
Finishes	White / Black	White
Bulbholder	50mm GU10 (except Power bulb)	111mm GU10
Code	<input type="radio"/> 3990-V3 <input type="radio"/> 3989-V3 <input checked="" type="radio"/> Custom RAL	<input type="radio"/> 4435 <input checked="" type="radio"/> Custom RAL

3 YEARS WARRANTY | 1/20

5 YEARS WARRANTY | 1/40

Consult delivery terms and conditions.

Accessories



Recessed base (not included)

4835 4836

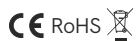

*GU10 bulbholder included.

IP 20 | 220/240 VAC |



Cookie 3PH

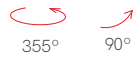
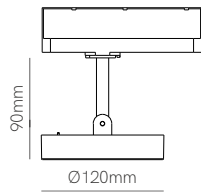

TRACK LIGHTS



Technical Information

Power	12W
Installation	Threee Phase Track
Color Temperature	Switch 2.700K / 3.200K / 4.000K
Lumens	985 lm
Material	Aluminium
Finishes	White / Black
Code	○ 5179 ● 5180



3 YEARS WARRANTY | 30.000 HOURS | IP 20 | 220/240 VAC | UGR <19 | PF >0,9 | CRI ≥90 | 38° | 50/60 Hz | TRIAC DIMM | +40°C / -20°C | CCT SWITCH | 1/20



▶ VIDEO



New

Oculum 3PH

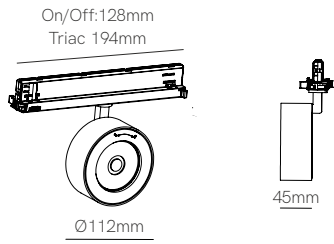

TRACK LIGHTS

Technical Information

Power	15W / 25W
Lumens	1.628 lm - 2.625 lm
Installation	Three Phase Track
Material	Aluminium
Finishes	White (9003) / Black (9005)

Code	Diffuser (Angle)	Power	CCT (Lm)	Driver	Colour
Code 7	Narrow (15°) N	15W 8	2.700K (95 lm/W) 2	On/Off 1	○ White 1
	Spot (22°) S	25W 9	3.000K (100 lm/W) 3	Triac 4	● Black 2
	Medium (36°) M		4.000K (105 lm/W) 4		
	Eliptic (30°-60°) E				

Code: 7 6

*Create your code according to your preferences.

ⓘ Consult delivery terms and conditions.

Accessories



Honeycomb Snoot anti-glare
● 20811



Oval diffuser
● 20833



Snoot
● 20855



Wallwasher
● 20877



5 YEARS WARRANTY | 50.000 HOURS | IP 40 | 220/240 VAC | PF >0,9 | CRI ≥90 | 15° 22° 36° 30°-60° | 50/60 Hz | TRIAC DIMM | +40°C -15°C | 1



Zoom 3PH



Power and CTT switch

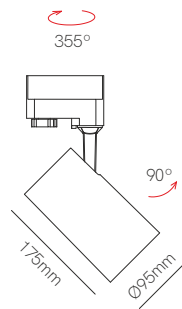
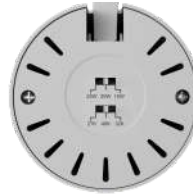

Technical Information

Power	Switch 15W / 20W / 25W
Installation	Three Phase Track
Color Temperature	Switch 2.700K / 3.200K / 4.000K
Lumens	15W: 1.200 lm / 20W: 1.500lm / 25W: 1.800 lm
Material	Aluminium and polycarbonate
Finishes	White / Black
Code	○ 4900 ● 4901



ⓘ Consult delivery terms and conditions.



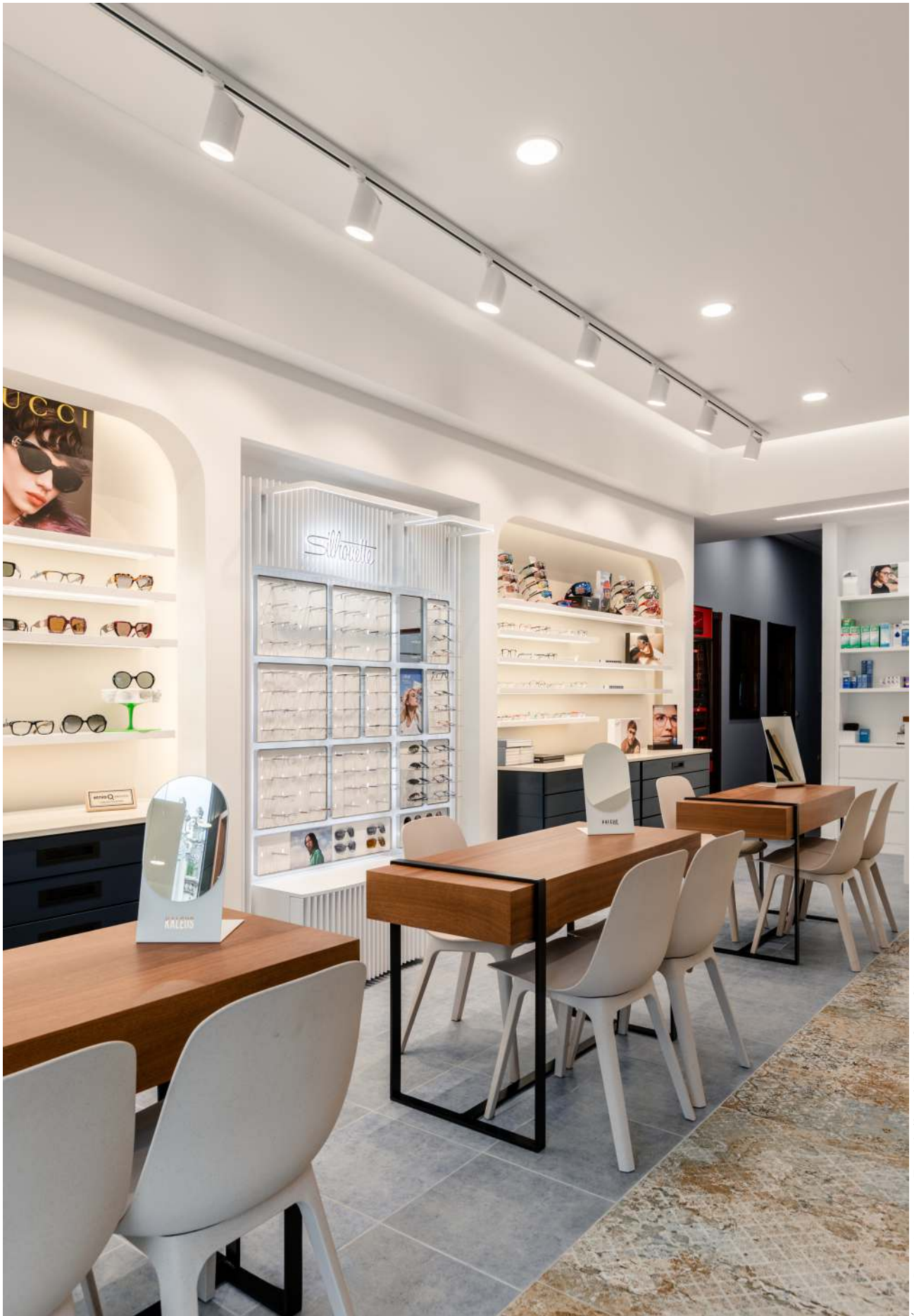

Óptica Rapp, La Laguna, Tenerife (Spain). Design: Grupo Globarq. Photography: Kuo estudio.

Aston 3PH

Konic 3PH

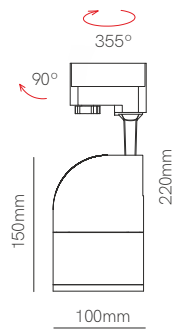
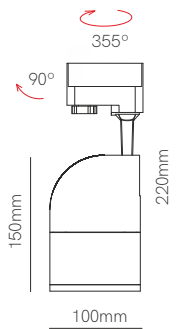

TRACK LIGHTS

Technical Information

Power	20W	30W
Installation	Three Phase Track	Three Phase Track
Color Temperature	Switch 2.700K / 3.200K / 4.000K	Switch 2.700K / 3.200K / 4.000K
Lumens	2.400 lm	2.440 lm
Material	Aluminium	Aluminium
Finishes	White / Black	White / Black

Code	○ 4439-N ● 4440-N ① Custom RAL	○ 4985-N ● 4986-N ① Custom RAL
------	---------------------------------------	---------------------------------------



① Consult delivery terms and conditions.

3 YEARS WARRANTY | 30.000 HOURS | → | IP 20 | 220/240 VAC | UGR <19 | PF >0,9 | | 15° 38° 60° | 50/60 Hz | +40°C -15°C | CCT SWITCH | 1/8

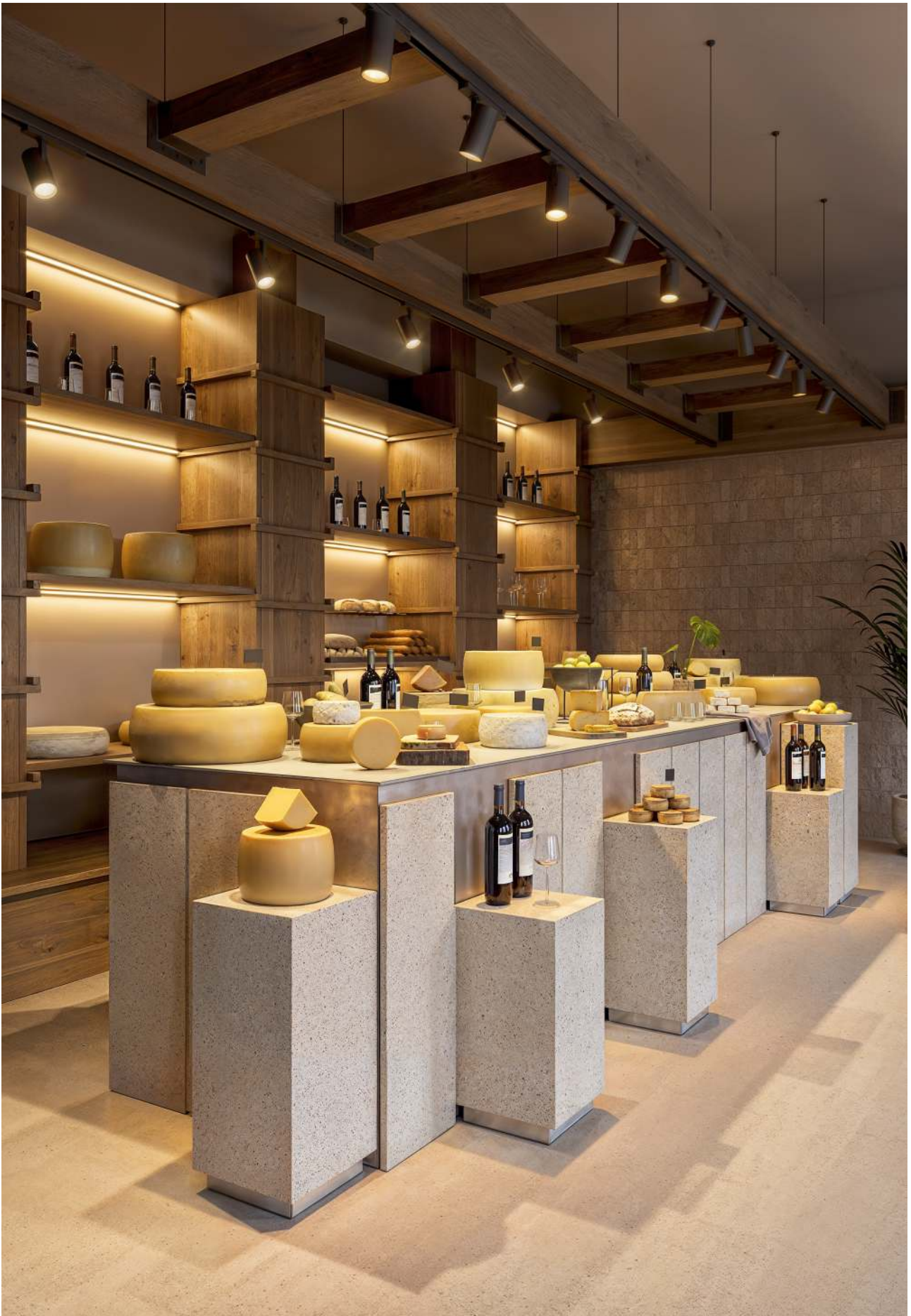

Lonja 3PH

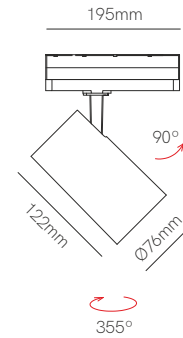

Technical Information

Power	22W
Lumens	1.628 lm - 2.662 lm
Installation	Three Phase Track
Material	Aluminium
Finishes	White (9003) / Black (9005)

Code	Diffuser (Angle)	Size	CCT (Lm)	Driver	Colour
Code 3	Transparent (15°)	1	9	FISH - 5.500K (121 lm/w)	1
	Transparent (24°)	6	3.000K (95 lm/w)	3	1
	Transparent (36°)	8	4.000K (100 lm/w)	4	2
			MEAT R - 1.950K (75 lm/w)	5	1
			FRUIT - 2.700K (105 lm/w)	6	2
			WINE/CHEESE - 2.700K (112 lm/w)	7	1
			BREAD - 2.400K (112 lm/w)	8	2
			MEAT M - 3.500K (74 lm/w)	9	1

Code: **3** **9**

*Create your code according to your preferences.

ⓘ Consult delivery terms and conditions.

Accessories

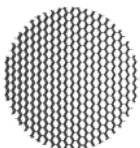

Honeycomb anti-glare

● 40111

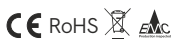

5 YEARS WARRANTY | 50.000 HOURS | → | IP 40 | 220/240 VAC | PF >0,9 | 3.000K 4.000K | | 15° 24° 36° | 50/60 Hz | TRIAC DIMM | +40°C -15°C | 1



▶ VIDEO



New

Lonja XL 3PH

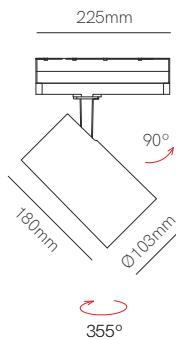

TRACK LIGHTS

Technical Information

Power	35W / 45W (Triac)
Lumens	2.450 lm - 5.265 lm
Installation	Three Phase Track
Material	Aluminium
Finishes	White (9003) / Black (9005)

Code	Diffuser (Angle)	Size	CCT (Lm)	Driver	Colour
Code 3	Narrow (15°) N	7	FISH - 5.500K (117 lm/w) 1	On/Off (45W) 1	○ White 1
	Spot (24°) S		2.700K (95 lm/w) 2	Triac (only 35W) 4	● Black 2
	Medium (40°) M		3.000K (100 lm/w) 3		🌈 Custom RAL
	Wide (60°) W		4.000K (105 lm/w) 4		
			Ⓜ MEAT R - 1.950K (70 lm/w) 5		
			Ⓜ FRUIT - 2.700K (100 lm/w) 6		
			Ⓜ BREAD - 2.400K (107 lm/w) 8		

Code: **3** **7**

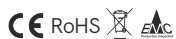

Ⓜ Consult delivery terms and conditions.
*Create your code according to your preferences.

5 YEARS WARRANTY | 50.000 HOURS | IP 40 | 220/240 VAC | PF >0,9 | CRI ≥90 | 2.700K | 3.000K | 4.000K | Ⓜ | 15° | 24° | 40° | 60° | 50/60 Hz | TRIAC DIMM | +40°C | -15°C | 1



Lena 3PH

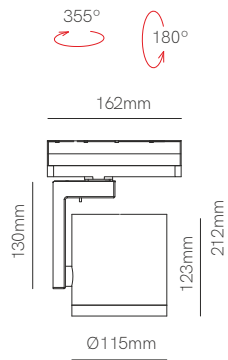

Technical Information

Power	35W
Installation	Three Phase Track
Color Temperature	Switch 2.700K / 3.200K / 4.000K
Lumens	4.200 lm
Material	Aluminium
Finishes	White / Black
Code	<input type="radio"/> 4449-V3 <input type="radio"/> 4450-V3 <input checked="" type="radio"/> Custom RAL



ⓘ Consult delivery terms and conditions.

3 YEARS WARRANTY | 30.000 HOURS | | IP 20 | 220/240 VAC | PF >0,9 | CRI ≥90 | | 15° / 38° / 60° | 50/60 Hz | +50°C / -20°C | CCT SWITCH | 1/8



Crown 3PH

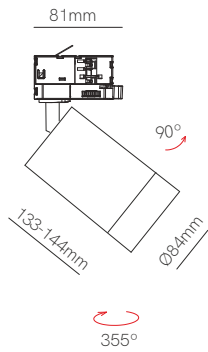

Technical Information

Power	25W
Installation	Three Phase Track
Color Temperature	Switch 2.700K / 3.200K / 4.000K
Lumens	2.300 lm
Material	Aluminium and polycarbonate
Finishes	White / Black
Code	○ 5221 ● 5222



3 YEARS WARRANTY | 25.000 HOURS | IP 20 | 220/240 VAC | UGR <19 | PF >0,9 | CRI ≥90 | ⚡ | 24° - 60° | 50/60 Hz | +40°C / -20°C | CCT SWITCH | 1/20



Kom 3PH 20W



Kom 3PH 30W



Kom 3PH 40W

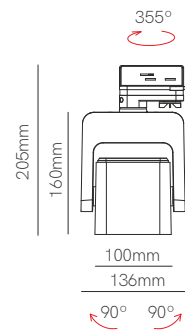
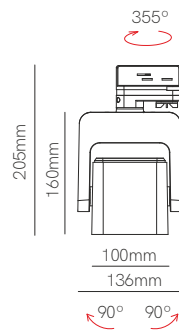
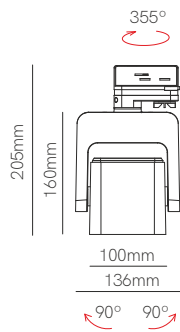

TRACK LIGHTS

Technical Information

Power	20W	30W	40W
Installation	Three Phase Track	Three Phase Track	Three Phase Track
Color Temperature	Switch 2.700K / 3.200K / 4.000K	Switch 2.700K / 3.200K / 4.000K	3.000K / 4.000K
Lumens	2.300 lm	2.470 lm	4.500 lm / 4.600 lm
Material	Aluminium	Aluminium	Aluminium
Finishes	White / Black	White / Black	White / Black

Code	<input type="checkbox"/> 4337-N	<input type="checkbox"/> 4336-N	<input type="checkbox"/> 3.000K 4444
	<input checked="" type="checkbox"/> 4339-N	<input checked="" type="checkbox"/> 4338-N	<input type="checkbox"/> 4.000K 4445
	Custom RAL	Custom RAL	<input checked="" type="checkbox"/> 3.000K 4447
			<input checked="" type="checkbox"/> 4.000K 4448
			Custom RAL



CRI ≥80

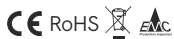

Consult delivery terms and conditions.

3 YEARS WARRANTY | 30.000 HOURS | → | IP 20 | 220/240 VAC | UGR <19 | PF >0,9 | | 15° 24° 40° | 50/60 Hz | +50°C -20°C | 1/10



Alfa 3PH

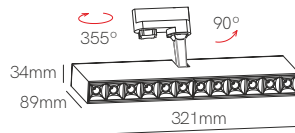

Technical Information

Power	32W
Installation	Three Phase Track
Color Temperature	2.700K / 3.000K / 4.000K
Lumens	3.100 lm / 3.200 lm / 3.250 lm
Material	Aluminium
Finishes	White / Black

Code	<input type="checkbox"/> 2.700K 4038
	<input type="checkbox"/> 3.000K 4039
	<input type="checkbox"/> 4.000K 4040
	<input checked="" type="checkbox"/> 2.700K 4176
	<input checked="" type="checkbox"/> 3.000K 4177
	<input checked="" type="checkbox"/> 4.000K 4178



5 YEARS WARRANTY | 30.000 HOURS | IP 20 | 220/240 VAC | UGR <19 | PF >0,9 | CRI ≥80 | 45° beam angle | 50/60 Hz | +40°C / -10°C | AKZO NOBEL | 1/10



Mini Tram 3PH

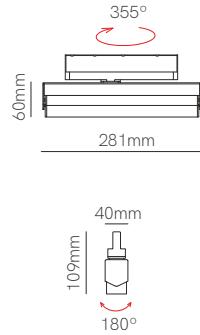

Tram 3PH

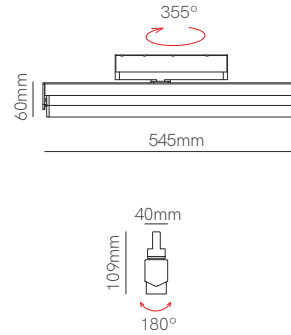

TRACK LIGHTS



Technical Information

Power	20W	30W
Installation	Three Phase Track	Three Phase Track
Color Temperature	3.000K / 4.000K	3.000K / 4.000K
Lumens	2.320 lm / 2.400 lm	3.520 lm / 3.600 lm
Material	Aluminium	Aluminium
Finishes	White / Black	White / Black

Code	<input type="checkbox"/> 3.000K 4427	<input type="checkbox"/> 3.000K 4541
	<input type="checkbox"/> 4.000K 4428	<input type="checkbox"/> 4.000K 4542
	<input checked="" type="checkbox"/> 3.000K 4429	<input checked="" type="checkbox"/> 3.000K 4543
	<input checked="" type="checkbox"/> 4.000K 4430	<input checked="" type="checkbox"/> 4.000K 4544

5 YEARS WARRANTY

3 YEARS WARRANTY



30.000 HOURS | IP 20 | 220/240 VAC | UGR <19 | PF >0,9 | CRI ≥80 | | 45° | 50/60 Hz | +45°C / -20°C | 1/10



ÚNICO (ICÓNICO & CO Gallery, Barcelona (Spain)). Photography: Pepo Úbeda.

Sono 3PH

Sono XL 3PH

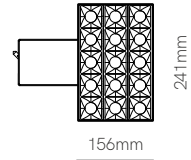
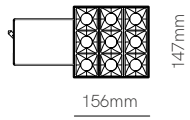
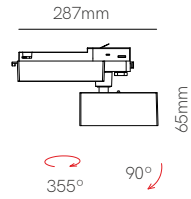
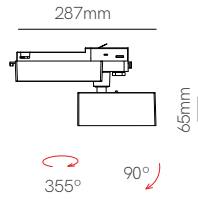

*Need Tuya Smart App to work.



Technical Information

Power	40W	60W
Installation	Three Phase Track	Three Phase Track
Color Temperature	Tuya 2.600K - 4.000K	Tuya 2.600K - 4.000K
Lumens	3.130 lm	4.390 lm
Material	Aluminium and polycarbonate	Aluminium and polycarbonate
Finishes	White / Black	White / Black
Code	<input type="checkbox"/> 4946 <input checked="" type="checkbox"/> 4947 <input checked="" type="checkbox"/> Custom RAL	<input type="checkbox"/> 4950 <input checked="" type="checkbox"/> 4951 <input checked="" type="checkbox"/> Custom RAL

Consult delivery terms and conditions.

Accessories



*See page 324 for Gateway additional info.

3 YEARS WARRANTY | 30.000 HOURS | IP 20 | 220/240 VAC | UGR <19 | PF >0,9 | CRI ≥98 | 30° beam angle | 50/60 Hz | IK06 | +45°C / -15°C | tuya | 1/4

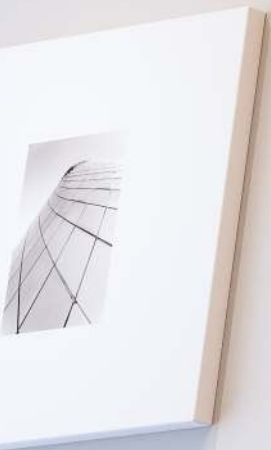

▶ VIDEO



Magnet track

mini





Magnet track 48V mini

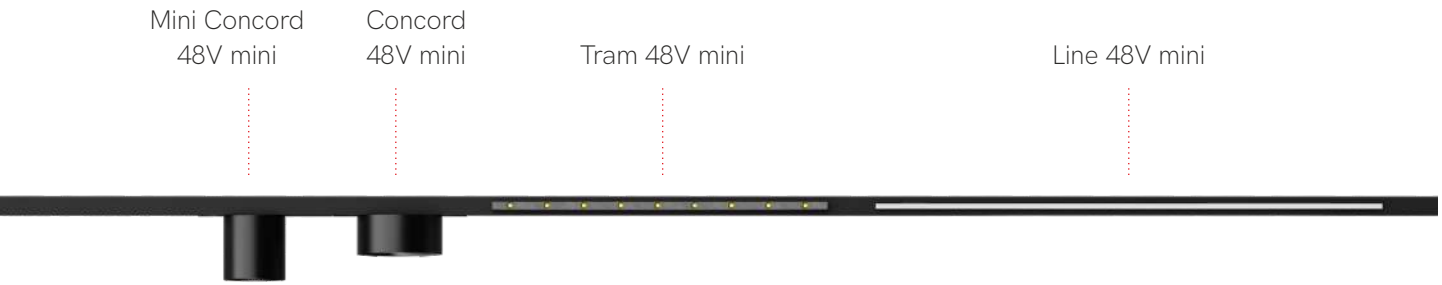

Beneito Faure introduces the mini magnetic track, developed to offer a punctual and decorative lighting in interior rooms. Its small size design makes it an ideal solution for domestic and decorative environments that need to highlight specific elements without interfering with the design of the space. The new collection includes a wide variety of products that are integrated into the track and switch on by magnetization on contact, guaranteeing a focused light emission at short angles, ideal for projects that require maximum precision.

Beneito Faure presenta el carril magnético mini, desarrollado para ofrecer una iluminación puntual y decorativa en estancias interiores. Su diseño de tamaño reducido lo convierte en una solución idónea para entornos domésticos y decorativos que necesitan resaltar elementos específicos sin interferir en el diseño del espacio.

La nueva colección incluye una amplia variedad de productos que se integran en el carril y se encienden por imantación al contactarlo, garantizando una emisión de luz focalizada con ángulos cortos, ideal para proyectos que exigen máxima precisión.

Magnet track mini accessories

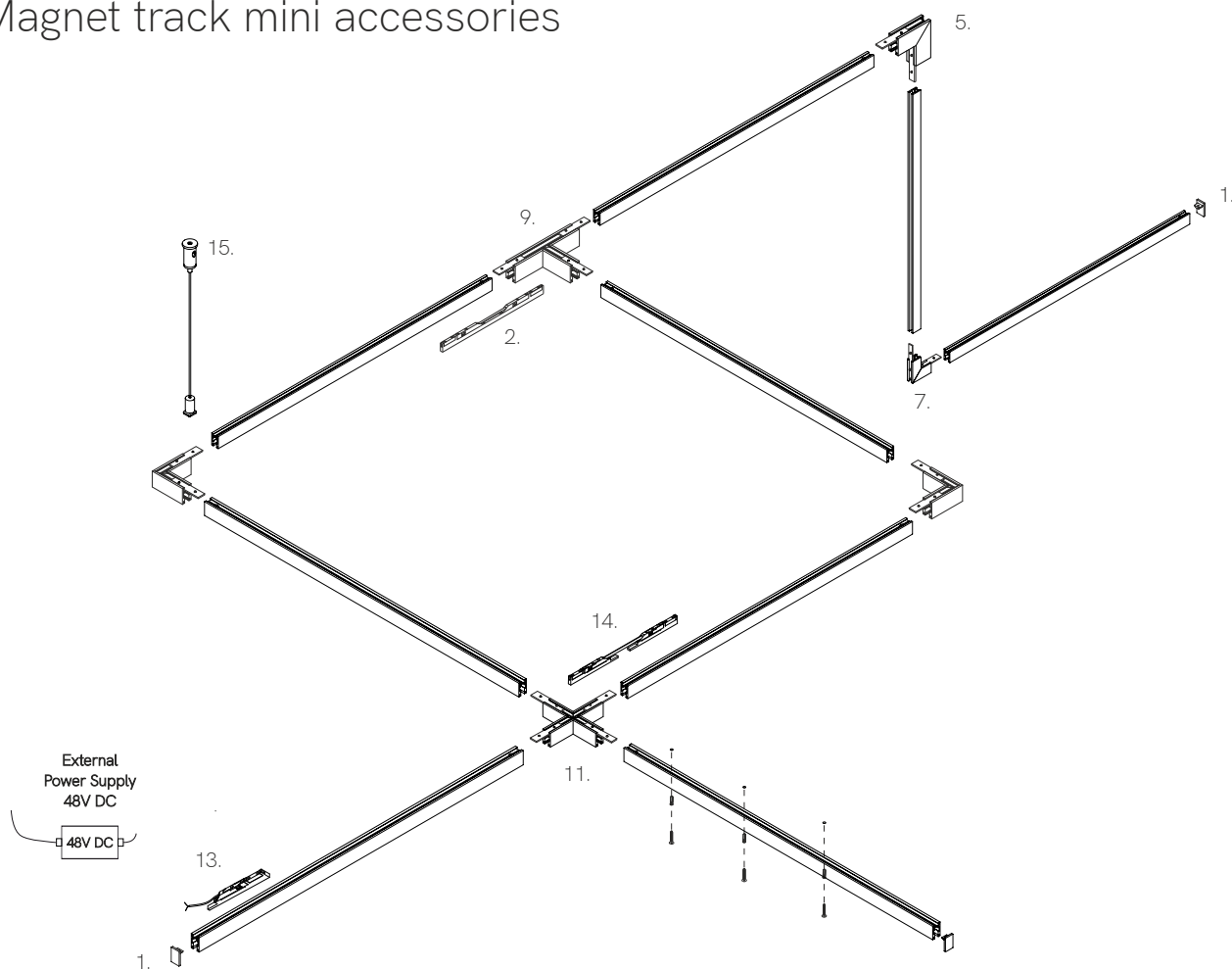

Power Supplies 48V mini

Code	Version	Power Max	IP	VDC OUT	Size
4725	<input type="checkbox"/> Power Supply	100W	IP20	48 VDC	350x30x18mm
4726	<input type="checkbox"/> Power Supply	150W	IP20	48 VDC	350x30x18mm
4727	<input type="checkbox"/> Power Supply	250W	IP20	48 VDC	400x40x22mm

Control Tuya/RF/Push (page 337)

Code	Version	Power Max	VDC IN	Size
22699	<input type="checkbox"/> NEW Controller Push/Tuya RF1C	1Cx10/15A	12-48 VDC	175x45x27mm
22571	<input type="checkbox"/> NEW Mini controller Tuya/RF/Push 1C	1C/5A	12-48 VDC	58x35,5x18mm

Control RF (page 327)

Code	Version	Power Max	V IN	Size
85890	<input checked="" type="checkbox"/> RF Dimming	-	3 VDC (CR2032)	139x36x11mm
85894	<input checked="" type="checkbox"/> RF Dimming 4 Zones	-	3 VDC (CR2032)	138x50x22mm
84431	<input type="checkbox"/> RF Dimming Panel	-	3 VDC (CR2032)	86x86x23mm
84432	<input checked="" type="checkbox"/> RF Dimming Panel	-	3 VDC (CR2032)	86x86x23mm
85144	<input checked="" type="checkbox"/> RF Dimming 4 Zone 2 Scenes	-	3VDC (CR2032)	86x86x9,5mm



Magnet track mini surface

W: 19,3mm H: 12mm

- 2m 5578
- 3m 5579
- 2m 5580
- 3m 5581



Magnet track mini recessed

W: 35mm x H: 16,7mm

- 2m 5582
- 3m 5583
- 2m 5584
- 3m 5585



L joint ceiling surface

L: 42mm W: 42mm H: 19,3mm

- 5594
- 5595



L joint ceiling recessed

L: 35mm W: 35mm H: 16,7mm

- 5606
- 5607



L joint wall ceiling outer surface

L: 42mm W: 42mm H: 19,3mm

- 5596
- 5597



L joint wall ceiling outer recessed

L: 35mm W: 35mm H: 16,7mm

- 5608
- 5609



L joint wall ceiling inner surface

L: 42mm W: 42mm H: 19,3mm

- 5598
- 5599

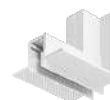

L joint wall ceiling inner recessed

L: 35mm W: 35mm H: 16,7mm

- 5610
- 5611



T joint ceiling surface

L: 84mm W: 48mm H: 19,3mm

- 5600
- 5601



T joint ceiling recessed

L: 84mm W: 48mm H: 16,7mm

- 5612
- 5613



X joint ceiling surface

L: 84mm W: 84mm H: 19,3mm

- 5602
- 5603



X joint ceiling recessed

L: 84mm W: 84mm H: 16,7mm

- 5614
- 5615



End cap surface / recessed

L: 12mm W: 5mm H: 19,3mm

- 5586
- 5587



Linear joint

L: 200mm W: 5mm H: 14mm

- 5590
- 5591



Start connector

L: 100mm W: 5mm H: 14mm

- 5588
- 5589



Suspension kit

L: 2.000mm W: 15mm

- 5604
- 5605



Central corner connector

L: 225mm W: 5mm H: 14mm

- 5592
- 5593





Mini Picolo 48V mini



Picolo 48V mini

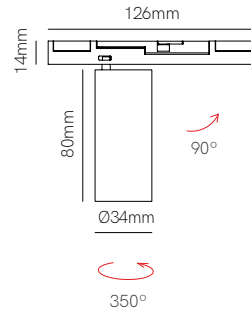
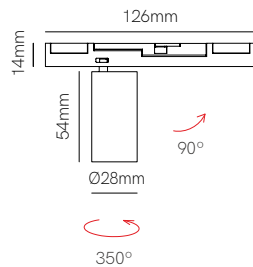

*Need power supply (page 392).



Technical Information

Power	6W	10W
Installation	Magnet track mini	Magnet track mini
Color Temperature	2.700K / 3.000K	2.700K / 3.000K
Lumens	380 lm / 415 lm	440 lm / 475 lm
Material	Aluminium	Aluminium
Finishes	White / Black	White / Black

Code	○	2.700K	5628	○	2.700K	5632
	○	3.000K	5629	○	3.000K	5633
	●	2.700K	5630	●	2.700K	5634
	●	3.000K	5631	●	3.000K	5635

1/48

1/36



3 YEARS WARRANTY | 26.000 HOURS | IP 20 | 48V DC | UGR <19 | CRI ≥90 | III | 36° | +40°C / -20°C



Atmos slim 48V mini

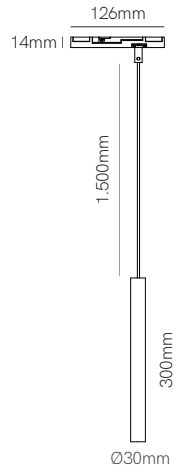

*Need power supply (page 392).



TRACK LIGHTS

Technical Information

Power	6W
Installation	Magnet track mini
Color Temperature	2.700K / 3.000K
Lumens	380 lm / 415 lm
Material	Aluminium
Finishes	White / Black

Code	○	2.700K	5636
	○	3.000K	5637
	●	2.700K	5638
	●	3.000K	5639



3 YEARS WARRANTY | 26.000 HOURS | IP 20 | 48V DC | UGR <19 | CRI ≥90 | III | 36° | +40°C / -20°C | 1/24



Zoe 48V mini



Zoe 48V mini suspension

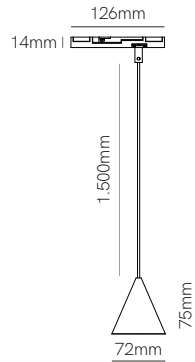
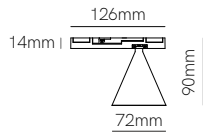

*Need power supply (page 392).



Technical Information

Power	6W	6W
Installation	Magnet track mini	Magnet track mini
Color Temperature	2.700K / 3.000K	2.700K / 3.000K
Lumens	375 lm / 410 lm	375 lm / 410 lm
Material	Aluminium	Aluminium
Finishes	White / Black	White / Black
Code	<ul style="list-style-type: none"> ○ 2.700K 5644 ○ 3.000K 5645 ● 2.700K 5646 ● 3.000K 5647 	<ul style="list-style-type: none"> ○ 2.700K 5640 ○ 3.000K 5641 ● 2.700K 5642 ● 3.000K 5643



3 YEARS WARRANTY | 26.000 HOURS | IP 20 | 48V DC | UGR <19 | CRI ≥90 | III | 36° | +40°C / -20°C | 1/36



Sphere 48V mini



Sphere 48V mini suspension

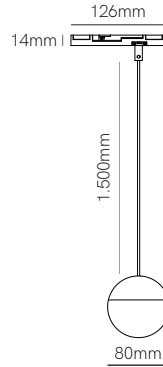
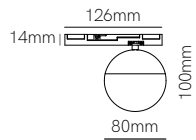
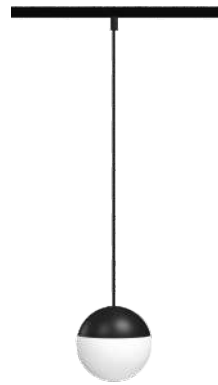

*Need power supply (page 392).



Technical Information

Power	7W	7W
Installation	Magnet track mini	Magnet track mini
Color Temperature	2.700K / 3.000K	2.700K / 3.000K
Lumens	380 lm / 415 lm	380 lm / 415 lm
Material	Aluminium	Aluminium
Finishes	White / Black	White / Black
Code	<ul style="list-style-type: none"> ○ 2.700K 5660 ○ 3.000K 5661 ● 2.700K 5662 ● 3.000K 5663 	<ul style="list-style-type: none"> ○ 2.700K 5656 ○ 3.000K 5657 ● 2.700K 5658 ● 3.000K 5659



3 YEARS WARRANTY | 26.000 HOURS | IP 20 | 48V DC | UGR <19 | CRI ≥90 | III | 100° | +40°C / -20°C | 1/36

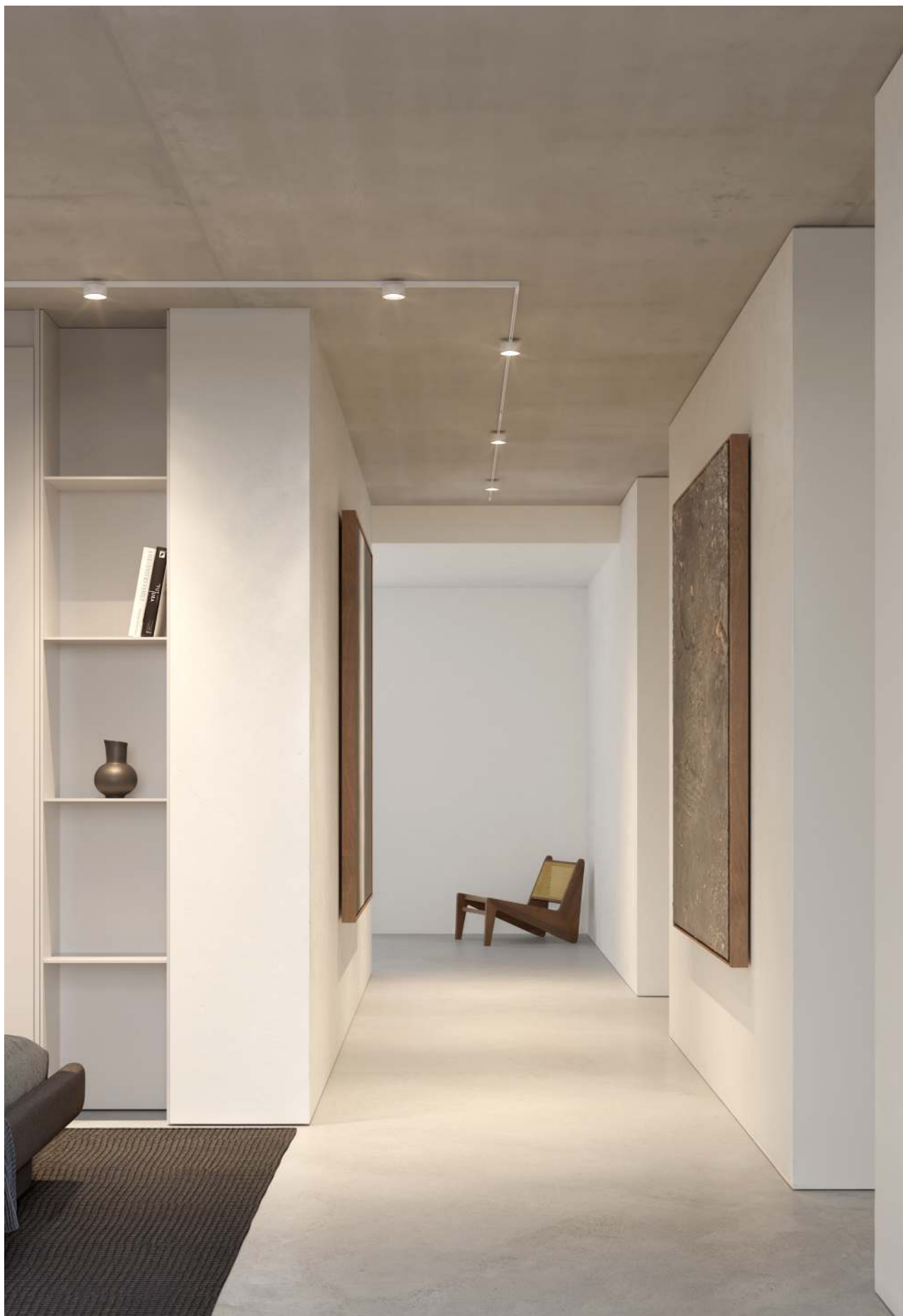

Mini Concord 48V mini

Concord 48V mini

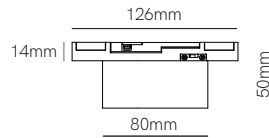
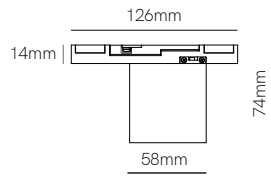

*Need power supply (page 392).



Technical Information

Power	8W	10W
Installation	Magnet track mini	Magnet track mini
Color Temperature	2.700K / 3.000K	2.700K / 3.000K
Lumens	290 lm / 315 lm	490 lm / 530 lm
Material	Aluminium	Aluminium
Finishes	White / Black	White / Black

Code	○ 2.700K 5652	○ 2.700K 5648
	○ 3.000K 5653	○ 3.000K 5649
	● 2.700K 5654	● 2.700K 5650
	● 3.000K 5655	● 3.000K 5651



Accessories

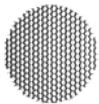

Honeycomb anti-glare
(Included)

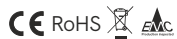

3 YEARS WARRANTY | 26.000 HOURS | IP 20 | 48V DC | UGR <19 | CRI ≥90 | III | 36° | +40°C / -20°C



Tram 48V mini

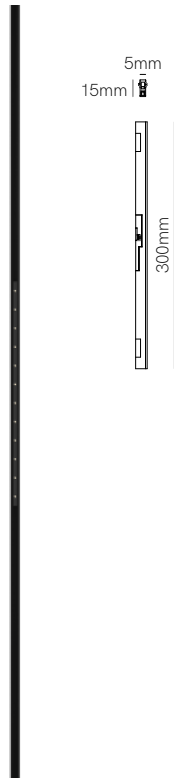

Mini Line 48V mini

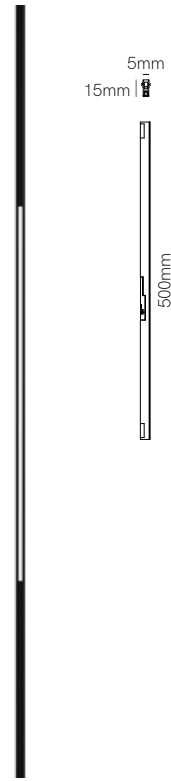

Line 48V mini

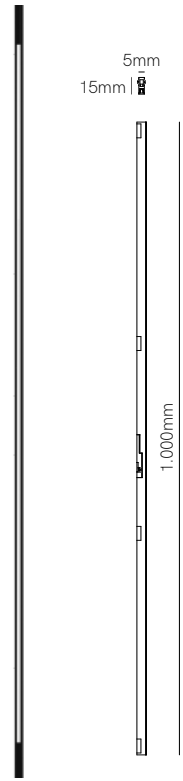

TRACK LIGHTS



*Need power supply (page 392).

Technical Information

Power	8W	8W	16W
Installation	Magnet track mini	Magnet track mini	Magnet track mini
Color Temperature	2.700K / 3.000K	2.700K / 3.000K	2.700K / 3.000K
Lumens	545 lm / 605 lm	300 lm / 325 lm	600 lm / 650 lm
Material	Aluminium	Aluminium	Aluminium
Finishes	White / Black	White / Black	White / Black
Code	<ul style="list-style-type: none"> ○ 2.700K 5624 ○ 3.000K 5625 ● 2.700K 5626 ● 3.000K 5627 	<ul style="list-style-type: none"> ○ 2.700K 5616 ○ 3.000K 5617 ● 2.700K 5618 ● 3.000K 5619 	<ul style="list-style-type: none"> ○ 2.700K 5620 ○ 3.000K 5621 ● 2.700K 5622 ● 3.000K 5623
	65° 1/60	100° 1/48	100° 1/36

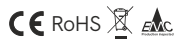

3 YEARS WARRANTY | 26.000 HOURS | IP 20 | 48V DC | UGR <19 | CRI ≥90 | | +40°C / -20°C





Magnet track

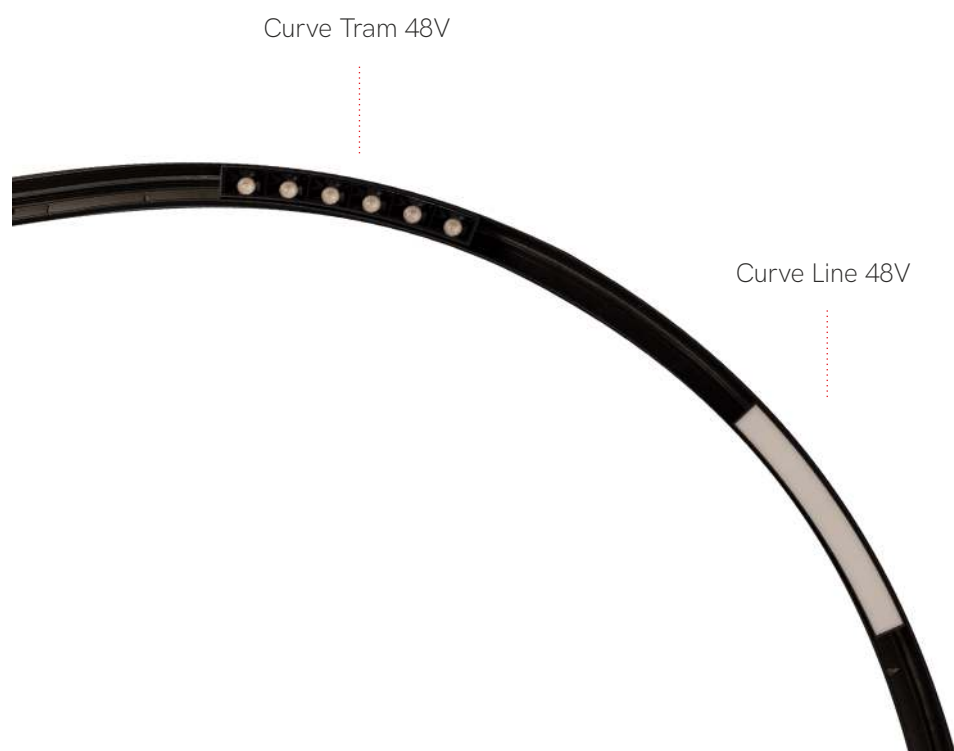
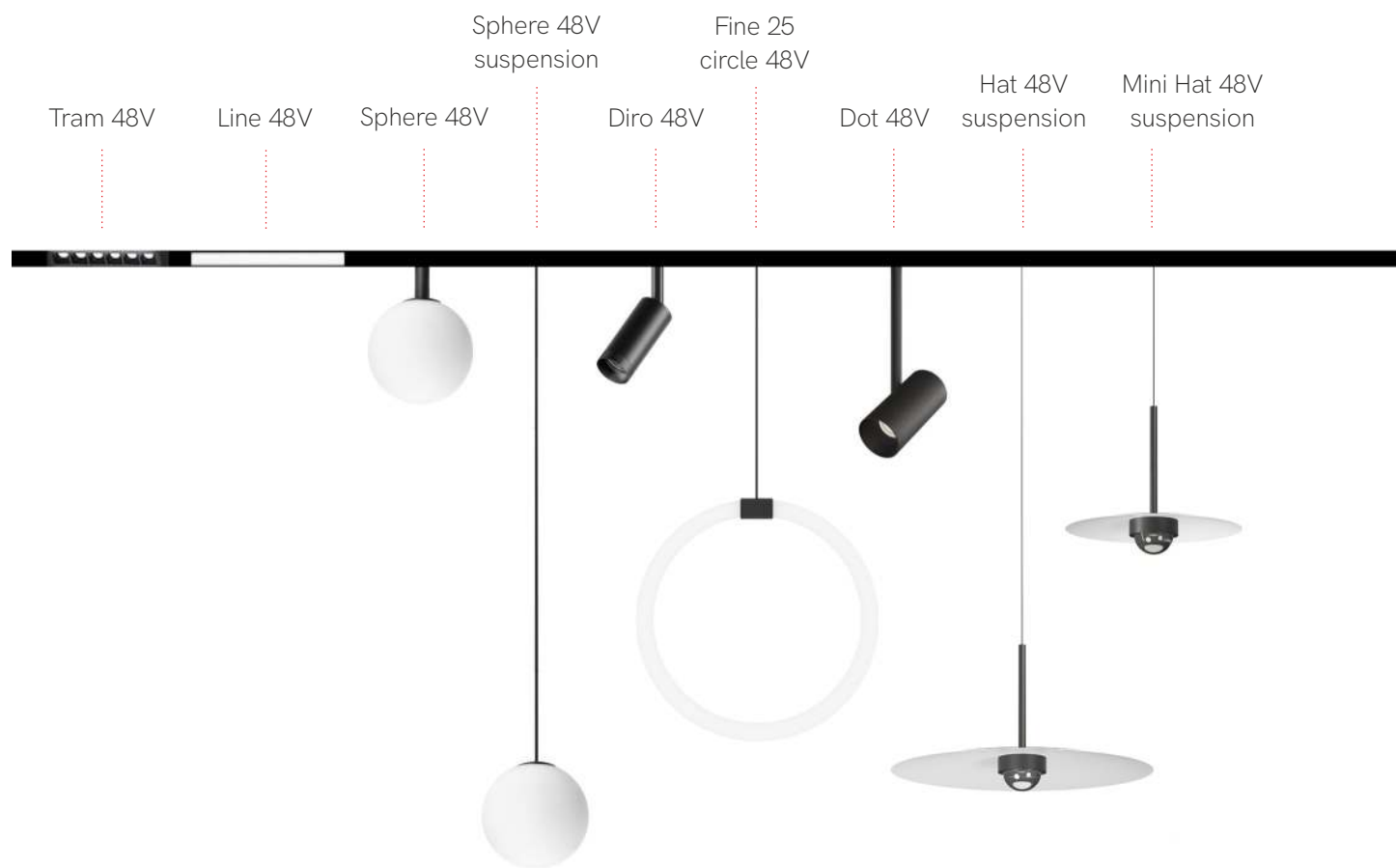

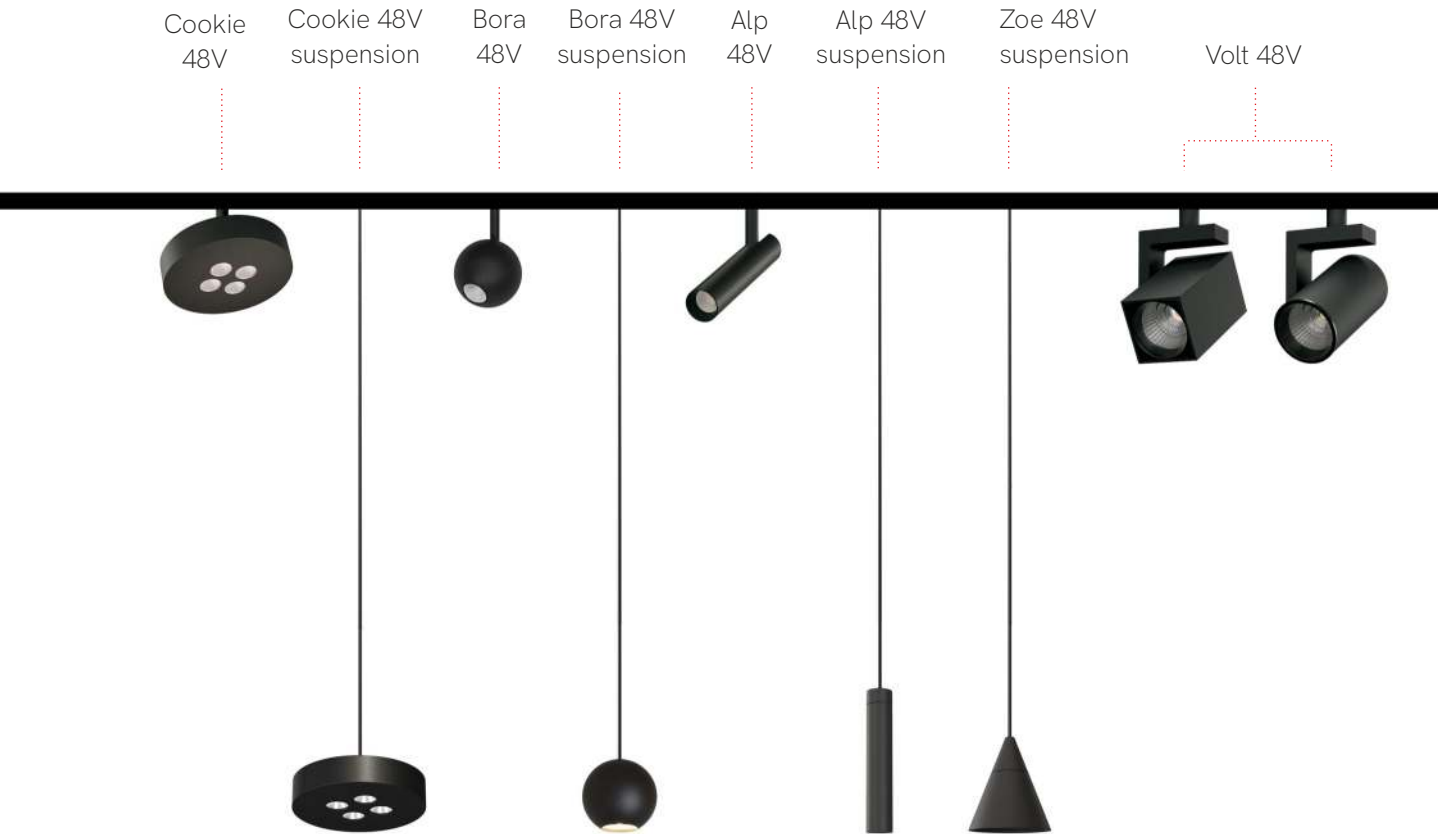

Magnet track 48V

Beneito Faure expands the collection for magnetic track and incorporates the mini Hat, a current trend in decorative lighting.

Thanks to the magnetized system, the spotlights are easily coupled and illuminate when they come into contact with the track.

Beneito Faure amplía la colección para carril magnético e incorpora mini Hat, tendencia actual en iluminación decorativa.

Gracias al sistema imantado los focos se acoplan de forma sencilla y se iluminan cuando entran en contacto con el carril.

Magnet track accessories

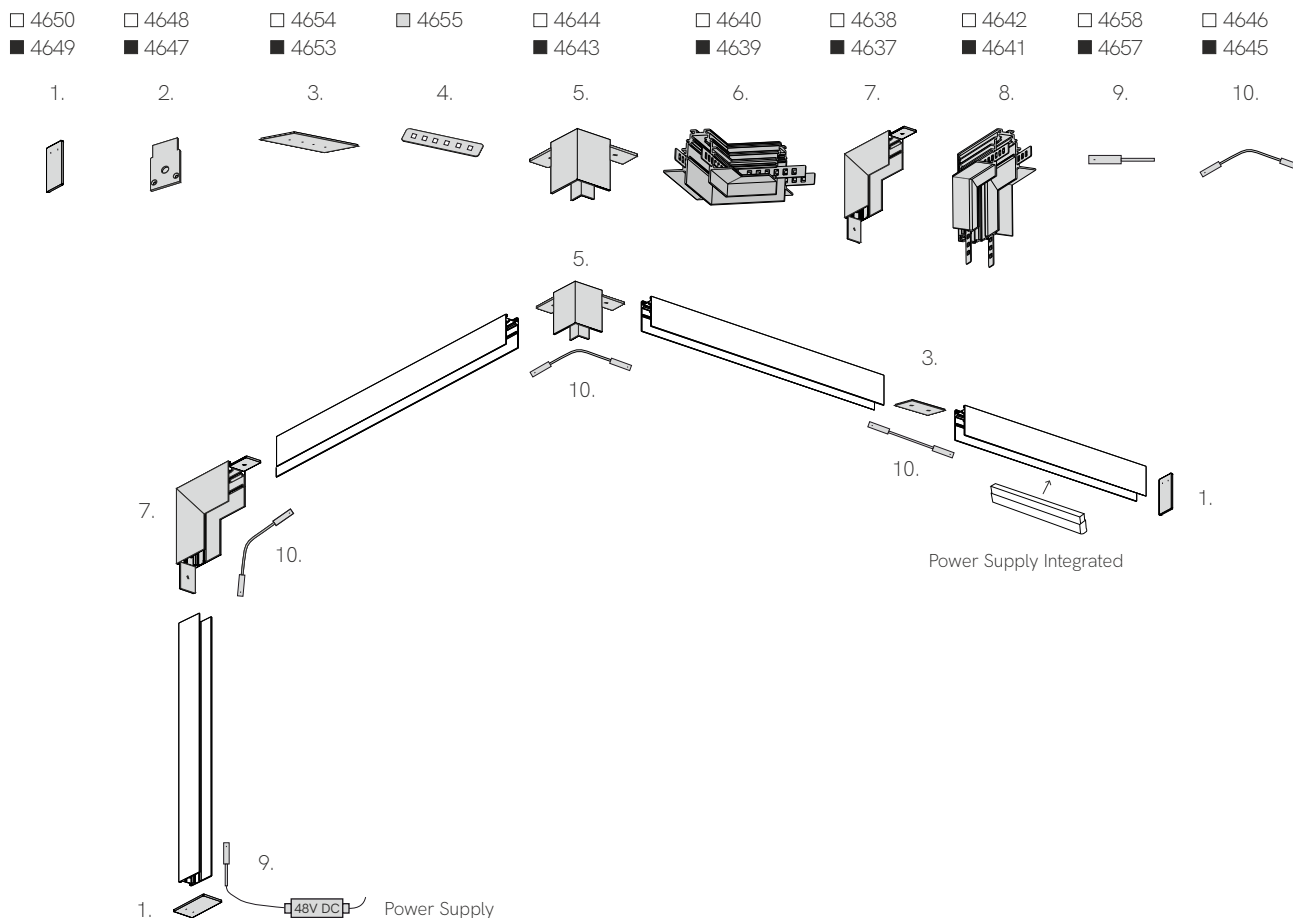

Power Supplies 48V



Code	Version	Power	IP	VDC OUT	Size
4711	■ Power Supply Basic	60W	IP67	48 VDC	150x53x36mm
4707	□ Power Supply Top	150W	IP65	48 VDC	219x63x35mm
4708	□ Power Supply Top	240W	IP65	48 VDC	244x71x37mm
5139	□ Power Supply Dali	90W	IP67	48 VDC	171x63x38mm
5140	□ Power Supply Dali	200W	IP67	48 VDC	191x68x40mm
5558	□ Power Supply Integrated Dali	100W	IP20	48 VDC	325x23x23mm
6023	■ Power Supply Integrated Dali	100W	IP20	48 VDC	325x23x23mm
5559	□ Power Supply Integrated Dali	250W	IP20	48 VDC	390x23x43mm
6025	■ Power Supply Integrated Dali	250W	IP20	48 VDC	390x23x43mm





Magnet track 48V surface

W: 26mm H: 53mm

- 1m 4660
- 2m 4662
- 1m 4659
- 2m 4661

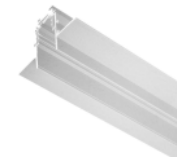

Magnet track 48V recessed

W: 72mm x H: 55mm

- 1m 4664
- 2m 4666
- 1m 4663
- 2m 4665

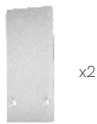

End cap 48V surface

L: 53mm W: 26.6mm H: 2mm

- 4650
- 4649



End cap 48V recessed

L: 52mm W: 32mm H: 2mm

- 4648
- 4647

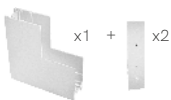

L joint wall ceiling 48V surface

L: 100mm W: 100mm H: 26mm

- 4638
- 4637

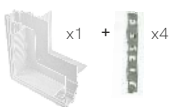

L joint wall ceiling 48V recessed

L: 100mm W: 100mm H: 72mm

- 4642
- 4641

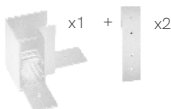

L joint 48V ceiling surface

L: 40mm W: 40mm H: 53mm

- 4644
- 4643



L joint 48V ceiling recessed

L: 100mm W: 100mm H: 55mm

- 4640
- 4639



Curve magnet track 48V surface

W: 26mm H: 53mm

- R500 1/4 5317
- R500 1/4 5319



Curve/straight end cap 48V

L: 53mm W: 26.6mm H: 2mm

- 4650-N
- 4649-N



Linear joint 48V surface

L: 80mm W: 22.5mm H: 2mm

- 4654
- 4653



Linear joint 48V recessed

L: 70mm W: 11.5mm H: 1mm

- 4655



Start connector 48V

L: 98mm W: 18mm H: 18mm

- 4658-N
- 4657-N



Central corner connector 48V

L: 98mm W: 18mm H: 18mm

- 4646-N
- 4645-N

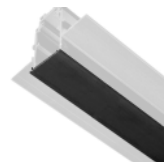

PVC trim 48V

W: 26.8mm H: 3.5mm

- 1m 4651
- 2m 4652



Suspension kit 48V

L: 45mm W: 22mm | Ø15mm H: 1.900mm

- 4807





Casambi magnet track control



CASAMBI is a master DALI device, using Bluetooth technology, suitable for monomaster applications, developed to control DALI lamps via mobile devices, using the Casambi app. 64 lamps (control gear) can be programmed, and assigned to up to 8 groups.

Power supply 24Vdc to 48Vdc, not polarized. Fused and protected against voltage peaks.
Two automatic programming modes, Standard and Fast Group, to program new lamps found on the bus.

Allows for the connection of up to 64 DALI lamps (control gear), assigning them to up to 8 groups.
Fixtures available for: Broadcast control, 8 groups, 4 TW groups.

The lamps on the bus are controlled by means of group commands: each lamp will execute only commands sent to its belonging group.

CASAMBI es un dispositivo maestro DALI, con tecnología Bluetooth, adecuado para aplicaciones monomáster, está desarrollado para controlar lámparas DALI a través de dispositivos móviles, utilizando la app Casambi. Se pueden programar 64 lámparas (equipo de control) y asignarlas a hasta un máximo de 8 grupos.

Fuente de alimentación de 24 Vdc a 48 Vdc, no polarizada, fusionada y protegida contra picos de voltaje. Dos modos de programación automática, Estándar y Grupo Rápido, para programar nuevas lámparas que se encuentren en el bus.

Permite la conexión de hasta 64 lámparas DALI (equipos auxiliares), asignándolas a un máximo de 8 grupos.
Dispositivos disponibles para: Control de difusión, 8 grupos, 4 grupos TW.
Las lámparas del bus se controlan mediante comandos de grupo: cada lámpara ejecutará sólo los comandos enviados a su grupo de pertenencia.

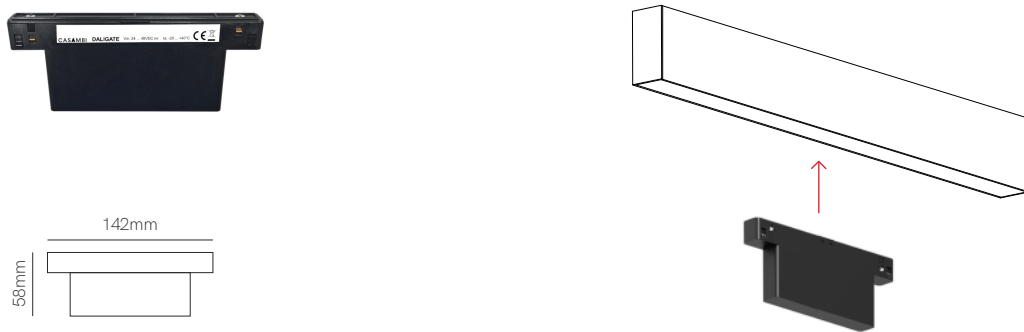

Code	Version	Power	IP	VDC OUT	Size
□ 6721	Casambi control 48V	8W	IP20	24-48 VDC	142x58x18mm
■ 6722	Casambi control 48V	8W	IP20	24-48 VDC	142x58x18mm

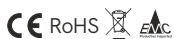



Alp 48V



Alp 48V suspension

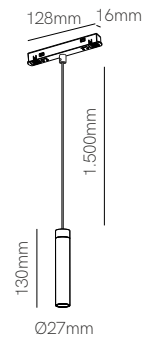
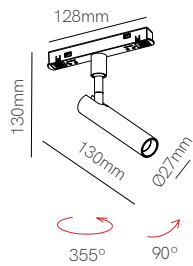

*Need power supply (page 410).

Technical Information

Power	4,5W	4,5W
Installation	Magnet Track	Magnet Track
Color Temperature	2.700K / 3.000K	2.700K / 3.000K
Lumens	260 lm / 270 lm	260 lm / 270 lm
Material	Aluminium	Aluminium
Finishes	White / Black	White / Black

Code	○ 2.700K 4787	○ 2.700K 4791
	○ 3.000K 4788	○ 3.000K 4792
	● 2.700K 4789	● 2.700K 4793
	● 3.000K 4790	● 3.000K 4794
	🌈 Custom RAL	🌈 Custom RAL

1/20

1/25

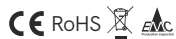

ⓘ Consult delivery terms and conditions.

3 YEARS WARRANTY | 26.000 HOURS | IP 20 | 48V DC | UGR <19 | CRI ≥90 | III | 38° | +40°C / -20°C



Mini Bora 48V

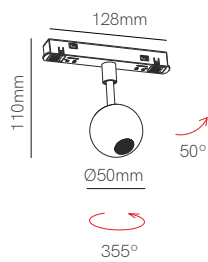

Bora 48V suspension

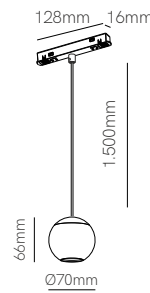

*Need power supply (page 410).



Technical Information

Power	4,5W	8,5W
Installation	Magnet Track	Magnet Track
Color Temperature	2.700K / 3.000K	2.700K / 3.000K
Lumens	315 lm / 325 lm	610 lm / 620 lm
Material	Aluminium	Aluminium
Finishes	White / Black / Chrome / Rose gold	White / Black / Chrome / Rose gold

Code	○ 2.700K 4581	○ 2.700K 4573
	○ 3.000K 4582	○ 3.000K 4574
	● 2.700K 4583	● 2.700K 4575
	● 3.000K 4584	● 3.000K 4576
	○ 2.700K 4585	○ 2.700K 4577
	○ 3.000K 4586	○ 3.000K 4578
	○ 2.700K 4587	○ 2.700K 4579
	○ 3.000K 4588	○ 3.000K 4580

UGR <10 | 38°

UGR <15 | 36°



3 YEARS WARRANTY | 26.000 HOURS | IP 20 | 48V DC | CRI ≥93 | III | +40°C / -20°C | 1/18



▶ VIDEO



Nano Tram 48V

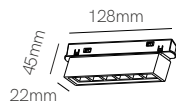

Mini Tram 48V

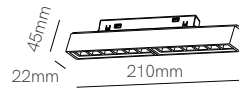

Curve Tram 48V

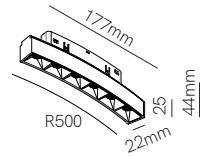

*Need power supply (page 410).



Technical Information

Power	4,5W	9W	6W
Installation	Magnet Track	Magnet Track	Magnet Track
Color Temperature	2.700K / 3.000K	2.700K / 3.000K	2.700K / 3.000K
Lumens	300 lm / 310 lm	690 lm / 710 lm	500 lm
Material	Aluminium	Aluminium	Aluminium
Finishes	White / Black	White / Black	White / Black

Code	<input type="checkbox"/> 2.700K 4776	<input type="checkbox"/> 2.700K 4780	<input type="radio"/> 2.700K 5309
	<input type="checkbox"/> 3.000K 4777	<input type="checkbox"/> 3.000K 4781	<input type="radio"/> 3.000K 5310
	<input checked="" type="checkbox"/> 2.700K 4778	<input checked="" type="checkbox"/> 2.700K 4782	<input checked="" type="radio"/> 2.700K 5311
	<input checked="" type="checkbox"/> 3.000K 4779	<input checked="" type="checkbox"/> 3.000K 4783	<input checked="" type="radio"/> 3.000K 5312
	26.000 HOURS 24° 1/50	26.000 HOURS 24° 1/50	30.000 HOURS 36° 1/40

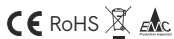

3 YEARS WARRANTY | IP 20 | 48V DC | UGR <19 | CRI ≥90 | | +40°C / -20°C



Nano Line 48V

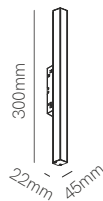

Mini Line 48V

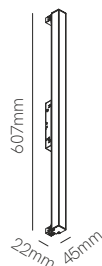

Line 48V

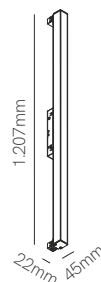

Curve Line 48V

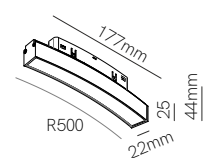

*Need power supply (page 410).

Technical Information

Power	7,5W	15W	30W	8W
Installation	Magnet Track	Magnet Track	Magnet Track	Magnet Track
Color Temperature	2.700K / 3.000K	2.700K / 3.000K	2.700K / 3.000K	2.700K / 3.000K
Lumens	310 lm / 320 lm	740 lm / 760 lm	1.000 lm / 1.050 lm	300 lm
Material	Aluminium	Aluminium	Aluminium	Aluminium
Finishes	Black	Black	Black	White / Black

Code	■ 2.700K 5202	■ 2.700K 5203	■ 2.700K 5204	○ 2.700K 5313
	■ 3.000K 4784	■ 3.000K 4785	■ 3.000K 4786	○ 3.000K 5314
	● 2.700K 5315			● 3.000K 5316

26.000 HOURS | |

26.000 HOURS | |

26.000 HOURS | |

30.000 HOURS | |



3 YEARS WARRANTY | IP 20 | 48V DC | UGR <19 | CRI ≥90 | | 100° | +40°C / -20°C



Diro 48V

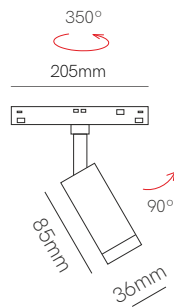

*Need power supply (page 410).

 Casambi magnet track control (page 413).



Technical Information

Power	7W
Installation	Magnet Track
Color Temperature	Dali 2.700K - 6.500K
Lumens	420 lm
Material	Aluminium
Finishes	White / Black
Code	<input type="radio"/> 5239 <input checked="" type="radio"/> 5238

Accessories

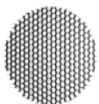

Honeycomb anti-glare
(Included)



5 YEARS WARRANTY | 50.000 HOURS | IP 20 | 48V DC | UGR <10 | CRI ≥90 |  | 36°  |  +40°C / -20°C |  | 1/20



Ifni Hairdresser, Gipuzkoa (Spain). Design: Basoko.eus Photography: Maider Agirre.

Zoe 48V suspension

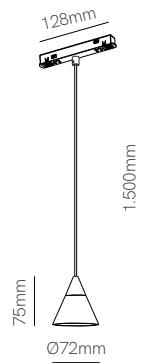

*Need power supply (page 410).

Technical Information

Power	7W
Installation	Magnet Track
Color Temperature	2.700K / 3.000K
Lumens	360 lm / 370 lm
Material	Aluminium
Finishes	White / Black

Code	△	2.700K	4795
	△	3.000K	4796
	▲	2.700K	4797
	▲	3.000K	4798
	①	Custom RAL	



① Consult delivery terms and conditions.

3 YEARS WARRANTY |
 26.000 HOURS |
 IP 20 |
 48V DC |
 UGR <19 |
 CRI ≥90 |
 III |
 38° |
 +40°C / -20°C |
 1/36



Mini Hat 48V suspension

Hat 48V suspension

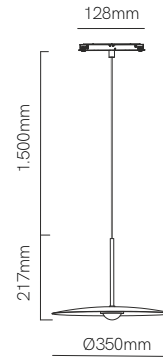
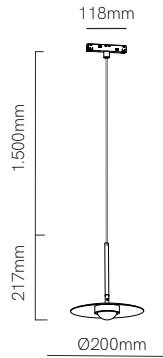

TRACK LIGHTS

*Need power supply (page 410).



Technical Information

Power	8W	8W
Installation	Magnet Track	Magnet Track
Color Temperature	2.700K / 3.000K	2.700K / 3.000K
Lumens	800 lm	800 lm
Material	Aluminium	Aluminium
Finishes	White / Black	White / Black

Code	○ 2.700K 5714	○ 2.700K 5363
	○ 3.000K 5716	○ 3.000K 5364
	● 2.700K 5715	● 2.700K 5366
	● 3.000K 5717	● 3.000K 5367

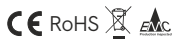

3 YEARS WARRANTY | 30.000 HOURS | → | IP 20 | 48V DC | | | +40°C / -20°C



Sphere 48V



Sphere 48V suspension

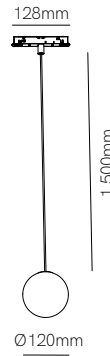
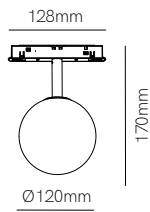

*Need power supply (page 410).

Technical Information

Power	8W	8W
Installation	Magnet Track	Magnet Track
Color Temperature	2.700K / 3.000K	2.700K / 3.000K
Lumens	430 lm	430 lm
Material	Aluminium and glass	Aluminium and glass
Finishes	White / Black	White / Black

Code	○ 2.700K 5369	○ 2.700K 5375
	○ 3.000K 5370	○ 3.000K 5376
	● 2.700K 5372	● 2.700K 5378
	● 3.000K 5373	● 3.000K 5379



3 YEARS WARRANTY | 30.000 HOURS | → | IP 20 | 48V DC | | 360° | +40°C / -20°C | 1/12



Volt r 48V

Volt sq 48V

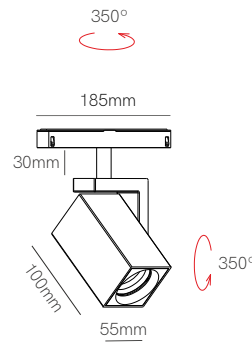
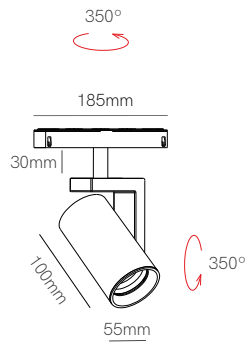



*Need power supply (page 410).

 Casambi magnet track control (page 413).



Technical Information

Power	8W	8W
Installation	Magnet Track	Magnet Track
Color Temperature	Dali 2.700K - 4.000K	Dali 2.700K - 4.000K
Lumens	570 lm	570 lm
Material	Aluminium	Aluminium
Finishes	White / Black	White / Black
Code	<input type="radio"/> 5037 <input checked="" type="radio"/> 5038 <input checked="" type="radio"/>  Custom RAL	<input type="checkbox"/> 5039 <input checked="" type="checkbox"/> 5040 <input checked="" type="checkbox"/>  Custom RAL

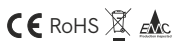

 Consult delivery terms and conditions.





Dot 48V

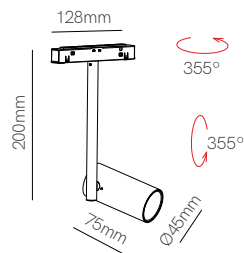

TRACK LIGHTS



*Need power supply (page 410).

Technical Information

Power	11W
Installation	Magnet Track
Color Temperature	2.700K / 3.000K
Lumens	680 lm / 690 lm
Material	Aluminium
Finishes	White / Black
Code	<ul style="list-style-type: none"> ○ 2.700K 4768 ○ 3.000K 4769 ● 2.700K 4770 ● 3.000K 4771 ① Custom RAL



① Consult delivery terms and conditions.

3 YEARS WARRANTY |
 26.000 HOURS |
 IP 20 |
 48V DC |
 UGR <19 |
 CRI ≥90 |
 III |
 35° |
 +40°C / -20°C |
 1/20



Cookie 48V

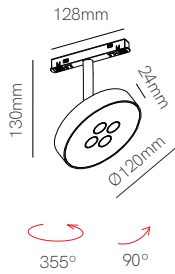

Cookie 48V

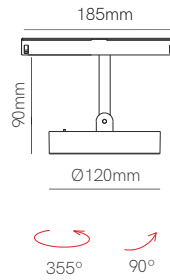

Cookie 48V suspension

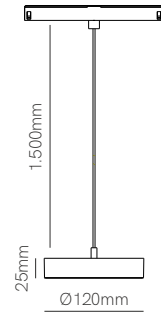
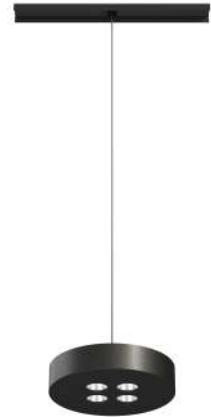



*Need power supply (page 410).

 Casambi magnet track control (page 413).



Technical Information

Power	12W	12W	12W
Installation	Magnet Track	Magnet Track	Magnet Track
Color Temperature	2.700K / 3.000K	Dali 2.700K - 4.000K	Dali 2.700K - 4.000K
Lumens	940 lm / 950 lm	500 lm - 700 lm	500 lm - 700 lm
Material	Aluminium	Aluminium	Aluminium
Finishes	White / Black	White / Black	White / Black

Code	<input type="radio"/> 2.700K 4772	<input type="radio"/> 5181	<input type="radio"/> 5185
	<input type="radio"/> 3.000K 4773	<input checked="" type="radio"/> 5182	<input checked="" type="radio"/> 5186
	<input checked="" type="radio"/> 2.700K 4774	<input type="radio"/>  Custom RAL	<input type="radio"/>  Custom RAL
	<input type="radio"/>  Custom RAL		

26.000 HOURS

30.000 HOURS



30.000 HOURS

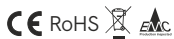

 Consult delivery terms and conditions.

3 YEARS WARRANTY | IP 20 | 48V DC | UGR <19 | CRI ≥90 |  38° |  +40°C / -20°C |  1/20



Fine 25 circle 48V

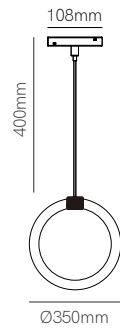
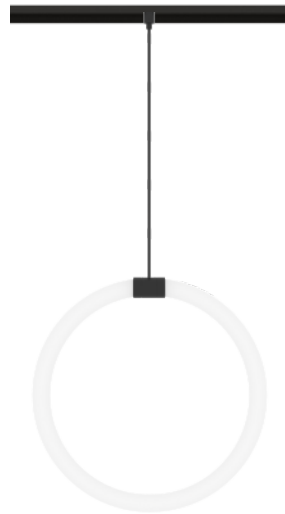

TRACK LIGHTS



*Need power supply (page 410).

Technical Information

Power	19W
Installation	Magnet Track
Color Temperature	3.000K / 4.000K
Lumens	850 lm / 950 lm
Finishes	Aluminium / Black

Code	○	3.000K	5431
	○	4.000K	5441
	●	3.000K	5432
	●	4.000K	5442



3 YEARS WARRANTY | 35.000 HOURS | IP 20 | 48V DC | CRI ≥90 | | 360° | +40°C / -20°C | 1



▶ VIDEO



A modern outdoor patio area at dusk. The ceiling is dark with multiple recessed linear track lights that are illuminated, casting a warm glow. The walls are made of dark, horizontal slats. In the foreground, there is a wooden dining table and four matching wooden chairs with grey cushions. On the table, there is a small potted plant and a decorative dome-shaped object. In the background, there is a large window or opening with three spotlights mounted on the ceiling, illuminating the outdoor area. The overall atmosphere is sophisticated and contemporary.

Outdoor
track



Outdoor track accessories



Outdoor Track IP

W: 26mm H: 25mm

- 5406 1m
- 5407 2m
- 5408 3m
- 5409 1m
- 5410 2m
- 5411 3m



Linear joint IP

L: 100mm W: 30mm H: 26mm

- 5414
- 5415



End cap IP

L: 62mm W: 30mm H: 26mm

- 5416
- 5417



L joint ceiling IP

L: 70mm W: 70mm H: 26mm

- 5412
- 5413



L joint wall ceiling IP

L: 70mm W: 70mm H: 30mm

- 5425
- 5426

TRACK LIGHTS



Power Supplies 48V



Code	Version	Power	IP	VDC OUT	Size
4711	<input checked="" type="checkbox"/> Power Supply Basic	60W	IP67	48 VDC	150x53x36mm
4707	<input type="checkbox"/> Power Supply Top	150W	IP65	48 VDC	219x63x35mm
4708	<input type="checkbox"/> Power Supply Top	240W	IP65	48 VDC	244x71x37mm





Frame 48V IP 1m

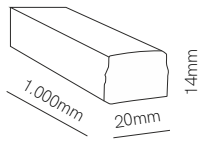

Frame 48V IP 2m

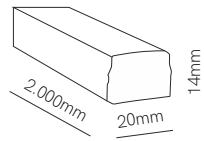

Frame 48V IP 3m

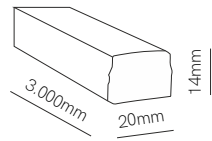

TRACK LIGHTS

*Need power supply (page 441).



Technical Information

Power	10W	20W	30W
Installation	Outdoor Track	Outdoor Track	Outdoor Track
Color Temperature	2.700K / 3.000K	2.700K / 3.000K	2.700K / 3.000K
Lumens	680 lm	1.400 lm	2.055 lm
Material	Silicone	Silicone	Silicone
Code	<input type="checkbox"/> 2.700K 5400 <input type="checkbox"/> 3.000K 5401	<input type="checkbox"/> 2.700K 5402 <input type="checkbox"/> 3.000K 5403	<input type="checkbox"/> 2.700K 5404 <input type="checkbox"/> 3.000K 5405

Accessories



Waterproof silicone cover IP (Needed when cut Frame)
 L: 20mm W: 14mm H: 4mm
 5418

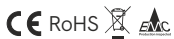

3 YEARS WARRANTY | 30.000 HOURS | IP 65 | 48V DC | CRI ≥90 | III | 100° | 125mm | IK06 | +45°C / -20°C | 1/15



Atmos slim 48V IP

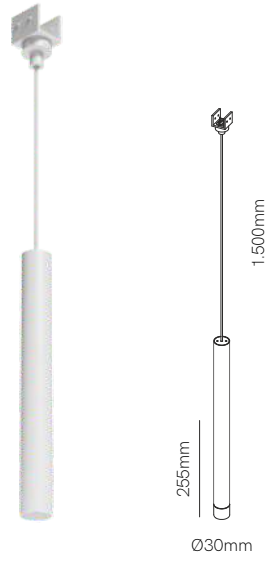

TRACK LIGHTS

*Need power supply (page 441).



Technical Information

Power	8W
Installation	Outdoor Track
Color Temperature	2.700K / 3.000K
Lumens	510 lm
Material	Aluminium
Finishes	White / Black

Code	○	2.700K	5392
	○	3.000K	5393
	●	2.700K	5394
	●	3.000K	5395



3 YEARS WARRANTY |
 30.000 HOURS |
 IP 65 |
 48V DC |
 UGR <19 |
 CRI ≥90 |
 III |
 38° |
 IK06 |
 +45°C / -20°C |
 1/20

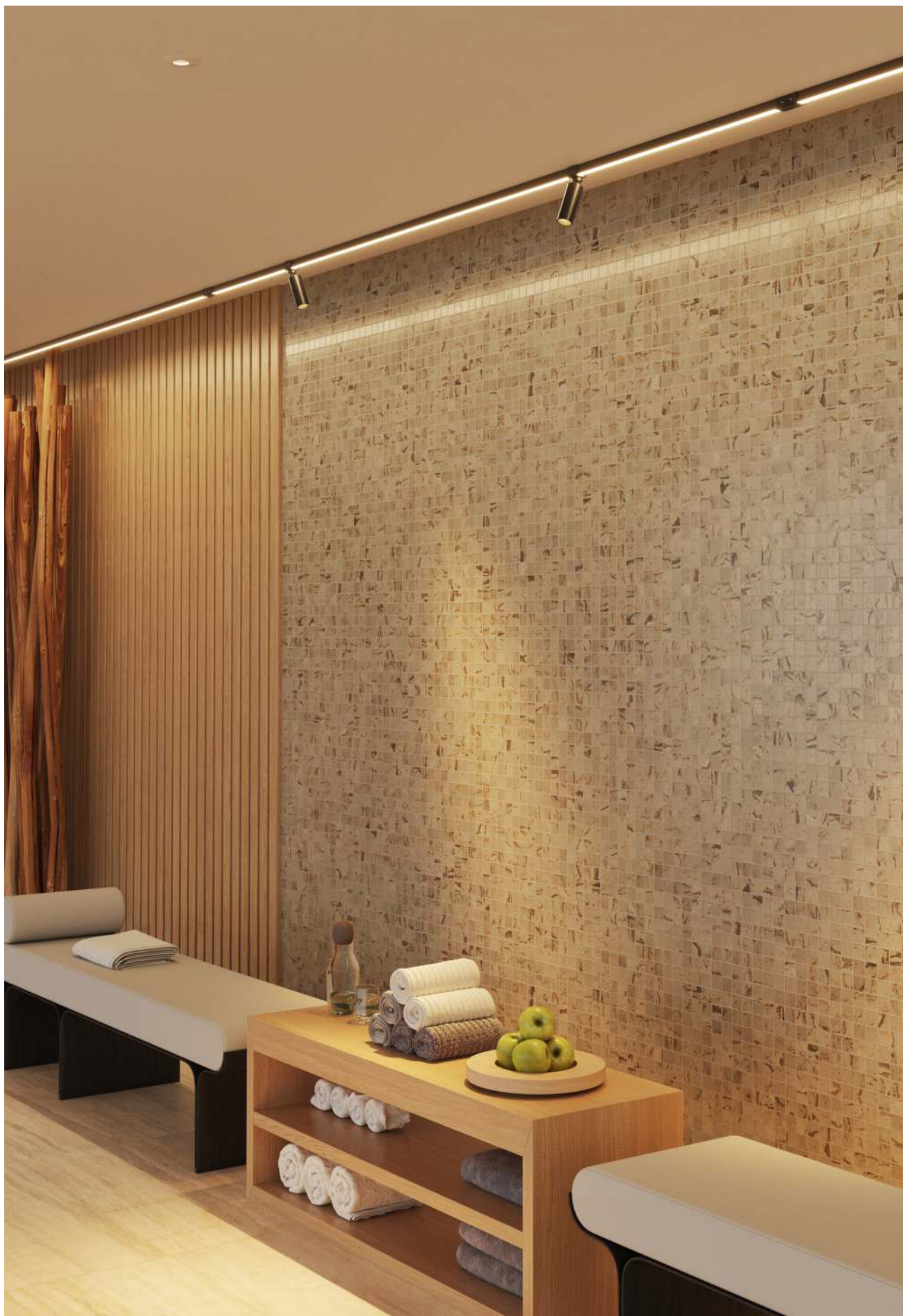

Bit 48V IP

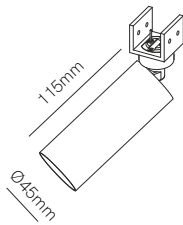

*Need power supply (page 441).



Technical Information

Power	8W
Installation	Outdoor Track
Color Temperature	2.700K / 3.000K
Lumens	630 lm
Material	Aluminium
Finishes	White / Black

Code	<input type="radio"/>	2.700K	5396
	<input type="radio"/>	3.000K	5397
	<input checked="" type="radio"/>	2.700K	5398
	<input checked="" type="radio"/>	3.000K	5399



3 YEARS WARRANTY |
 30.000 HOURS |
 IP 65 |
 48V DC |
 UGR <19 |
 CRI ≥90 |
 III |
 55° |
 IK06 |
 +45°C / -20°C |
 1/20



Ice 48V IP

Ice XL 48V IP

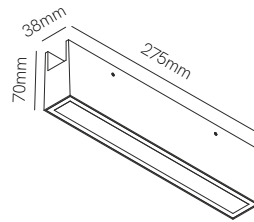
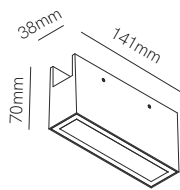

TRACK LIGHTS

*Need power supply (page 441).



Technical Information

Power	10W	20W
Installation	Outdoor Track	Outdoor Track
Color Temperature	2.700K / 3.000K	2.700K / 3.000K
Lumens	685 lm	1.110 lm
Material	Aluminium	Aluminium
Finishes	White / Black	White / Black

Code	<input type="checkbox"/> 2.700K	5384	<input type="checkbox"/> 2.700K	5388
	<input type="checkbox"/> 3.000K	5385	<input type="checkbox"/> 3.000K	5389
	<input checked="" type="checkbox"/> 2.700K	5386	<input checked="" type="checkbox"/> 2.700K	5390
	<input checked="" type="checkbox"/> 3.000K	5387	<input checked="" type="checkbox"/> 3.000K	5391

1/40

1/20



3 YEARS WARRANTY | 30.000 HOURS | IP 65 | 48V DC | UGR <19 | CRI ≥90 | III | 45° | IK06 | +45°C / -20°C