



Surface

SURFACE



Nano Golf surface

Mini Golf surface

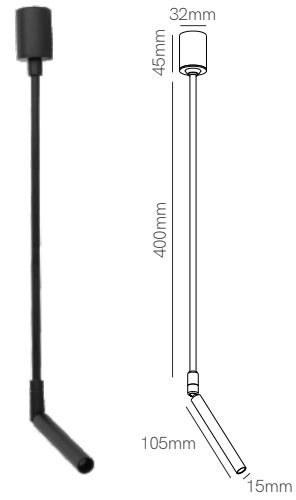
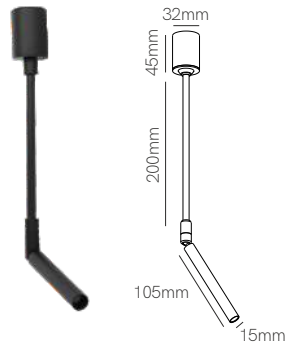

Technical Information

Power	3,5W	3,5W
Installation	Surface	Surface
Color Temperature	2.700K / 3.000K / 4.000K	2.700K / 3.000K / 4.000K
Lumens	125 lm	125 lm
Material	Aluminium	Aluminium
Finishes	White / Black	White / Black

Code	<input type="radio"/> 2.700K 5285	<input type="radio"/> 2.700K 5291
	<input type="radio"/> 3.000K 5286	<input type="radio"/> 3.000K 5292
	<input type="radio"/> 4.000K 5287	<input type="radio"/> 4.000K 5293
	<input checked="" type="radio"/> 2.700K 5288	<input checked="" type="radio"/> 2.700K 5294
	<input checked="" type="radio"/> 3.000K 5289	<input checked="" type="radio"/> 3.000K 5295
	<input checked="" type="radio"/> 4.000K 5290	<input checked="" type="radio"/> 4.000K 5296



3 YEARS WARRANTY | 35.000 HOURS | IP 20 | 220/240 VAC | UGR <19 | PF >0,5 | CRI ≥90 | | 24° | 50/60 Hz | +40°C / -20°C | 1/10

Golf surface

Golf XL surface



SURFACE

Technical Information

Power	3,5W	3,5W
Installation	Surface	Surface
Color Temperature	2.700K / 3.000K / 4.000K	2.700K / 3.000K / 4.000K
Lumens	125 lm	125 lm
Material	Aluminium	Aluminium
Finishes	White / Black	White / Black

Code	○ 2.700K 5297	○ 2.700K 5303
	○ 3.000K 5298	○ 3.000K 5304
	○ 4.000K 5299	○ 4.000K 5305
	● 2.700K 5300	● 2.700K 5306
	● 3.000K 5301	● 3.000K 5307
	● 4.000K 5302	● 4.000K 5308



3 YEARS WARRANTY | 35.000 HOURS | IP 20 | 220/240 VAC | UGR <19 | PF >0,5 | CRI ≥90 | 24° | 50/60 Hz | +40°C / -20°C | 1/10



Mini Bora surface

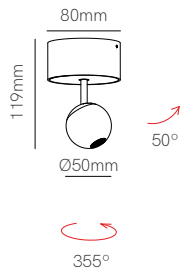

Bora surface

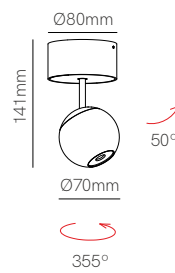

Technical Information

Power	4,5W	8,5W
Installation	Surface	Surface
Color Temperature	2.700K / 3.000K	2.700K / 3.000K
Lumens	290 lm / 300 lm	530 lm / 540 lm
Material	Aluminium	Aluminium
Finishes	White / Black / Chrome / Rose gold	White / Black / Chrome / Rose gold

Code	○ 2.700K 4621	○ 2.700K 4629
	○ 3.000K 4622	○ 3.000K 4630
	● 2.700K 4623	● 2.700K 4631
	● 3.000K 4624	● 3.000K 4632
	○ 2.700K 4625	○ 2.700K 4633
	○ 3.000K 4626	○ 3.000K 4634
	○ 2.700K 4627	○ 2.700K 4635
	○ 3.000K 4628	○ 3.000K 4636

UGR <10 | PF >0,5 | 38°

UGR <15 | PF >0,6 | 36°



3 YEARS WARRANTY | 26.000 HOURS | IP 20 | 220/240 VAC | CRI >93 | 50/60 Hz | +40°C / -20°C | 1/18



Alp surface

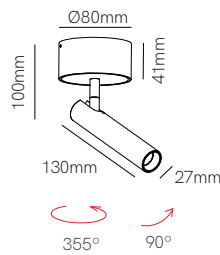

Technical Information

Power	4,5W
Installation	Surface
Color Temperature	2.700K / 3.000K
Lumens	220 lm
Material	Aluminium
Finishes	White / Black

Code	○	2.700K	5357
	○	3.000K	5358
	●	2.700K	5360
	●	3.000K	5361



3 YEARS WARRANTY | 30.000 HOURS | IP 20 | 220/240 VAC | UGR <19 | PF >0,5 | CRI ≥90 | ⚡ | 36° | 50/60 Hz | +40°C / -20°C | 1/18

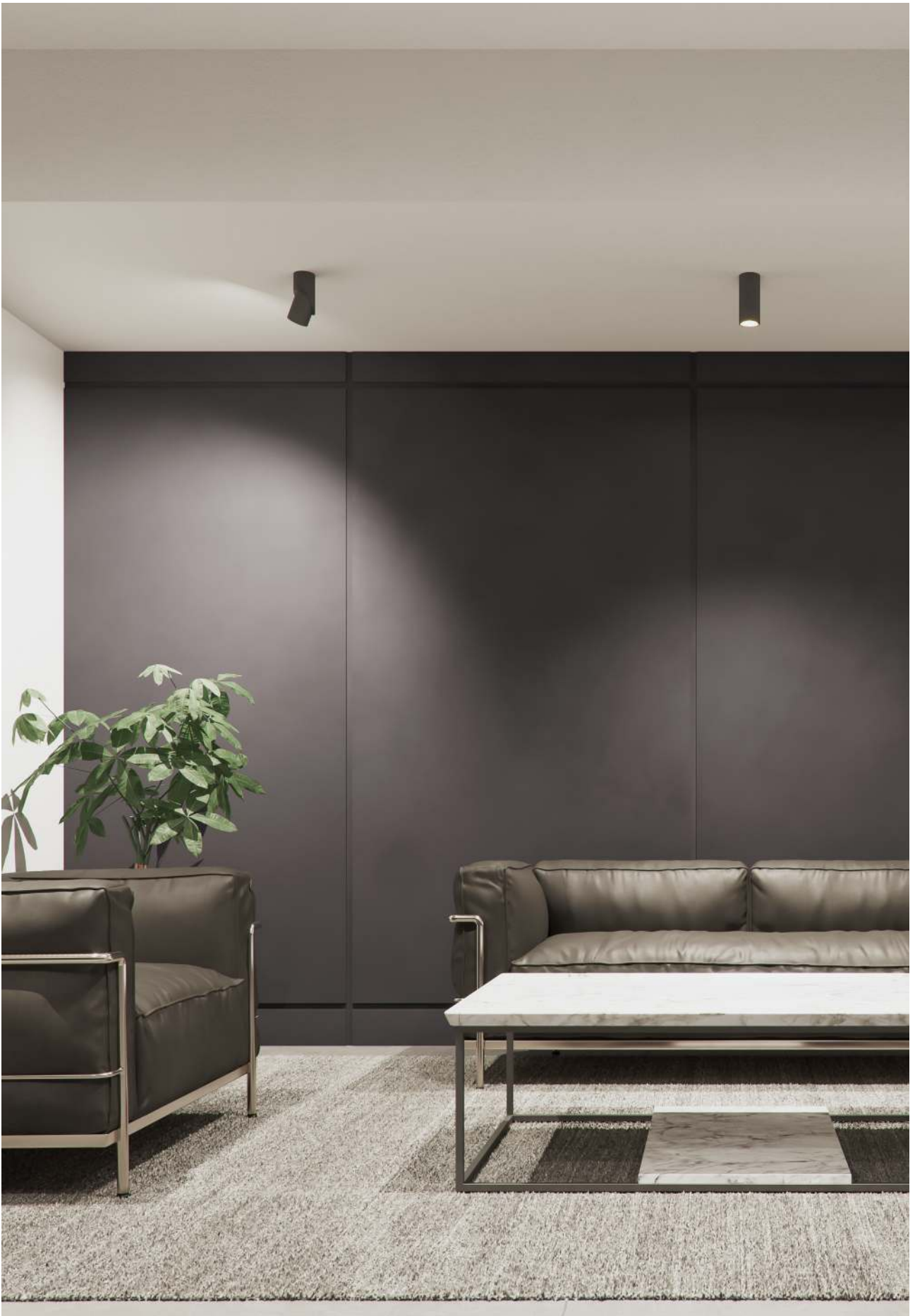

Plus surface

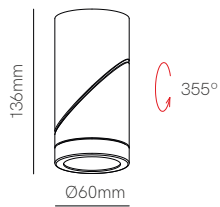

Technical Information

Power	8W
Installation	Surface
Color Temperature	Switch 2.700K / 3.200K / 4.000K
Lumens	1.040 lm
Material	Aluminium
Finishes	White / Black

Code	<input type="radio"/> 4522 <input type="radio"/> 4523 <input checked="" type="radio"/> Custom RAL
------	---



ⓘ Consult delivery terms and conditions.

3 YEARS WARRANTY | 30.000 HOURS | IP 20 | 220/240 VAC | PF >0,9 | CRI ≥80 |
 [Square Icon] | 15° | 35° | 60° [Beam Spread Icons] | 50/60 Hz |
 [Thermometer Icon] +45°C | -20°C | [Switch Icon] CCT SWITCH | [Box Icon] 1/20

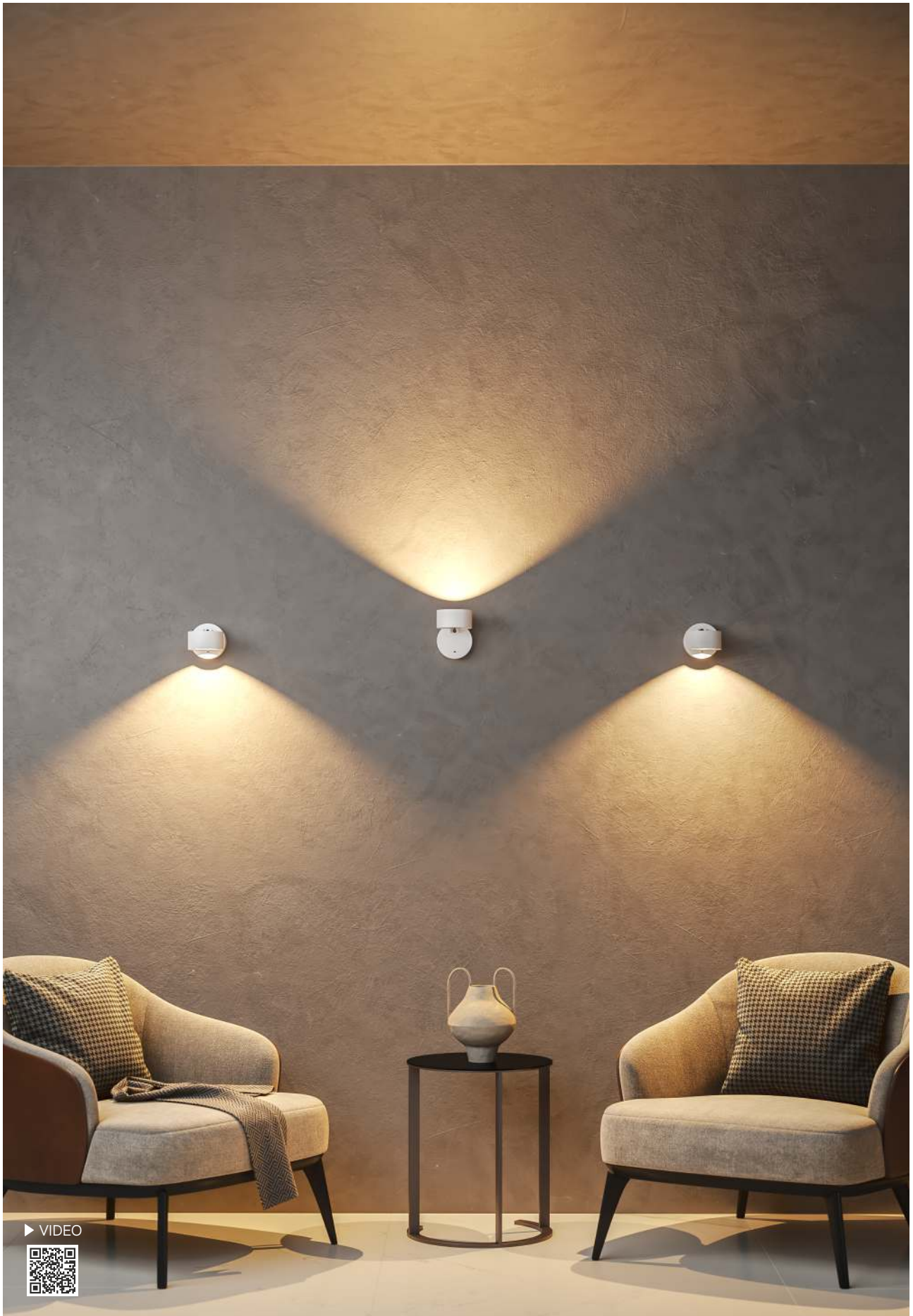

▶ VIDEO



Mini Concord surface

Concord surface

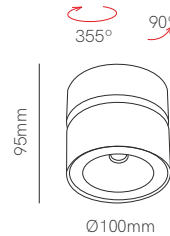
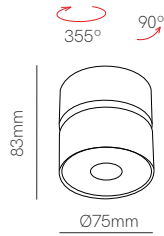

Technical Information

Power	7W	14W
Installation	Surface	Surface
Color Temperature	Switch 2.700K / 3.200K / 4.000K	Switch 2.700K / 3.200K / 4.000K
Lumens	850 lm	1.205 lm
Material	Aluminium	Aluminium
Finishes	White / Black	White / Black

Code	<input type="radio"/> 4334-N	<input type="radio"/> 5071
	<input type="radio"/> 4335-N	<input type="radio"/> 5072
	<input checked="" type="radio"/> Custom RAL	<input checked="" type="radio"/> Custom RAL

CRI ≥80 | 1/30

CRI ≥97 | 1/4/12



ⓘ Consult delivery terms and conditions.

3 YEARS WARRANTY | 30.000 HOURS | IP 20 | 220/240 VAC | PF >0,9 | 40° | 50/60 Hz | +40°C / -10°C | TRIAC DIMM | CCT SWITCH



Mini Rubyc surface

Rubyc surface

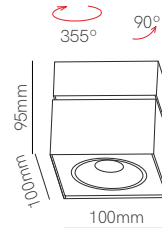
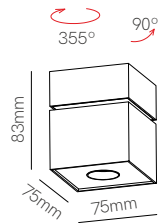

Technical Information

Power	7W	14W
Installation	Surface	Surface
Color Temperature	Switch 2.700K / 3.200K / 4.000K	Switch 2.700K / 3.200K / 4.000K
Lumens	850 lm	1.205 lm
Material	Aluminium	Aluminium
Finishes	White / Black	White / Black

Code	<input type="checkbox"/> 4332-N	<input type="checkbox"/> 5069
	<input checked="" type="checkbox"/> 4333-N	<input checked="" type="checkbox"/> 5070
	Custom RAL	Custom RAL

CRI ≥80 | 1/30

CRI ≥97 | 1/4/12

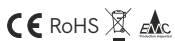

Consult delivery terms and conditions.

3 YEARS WARRANTY |
 30.000 HOURS |
 IP 20 |
 220/240 VAC |
 PF >0,9 |
 |
 40° |
 |
 50/60 Hz |
 +40°C / -10°C |
 TRIAC DIMM |
 CCT SWITCH

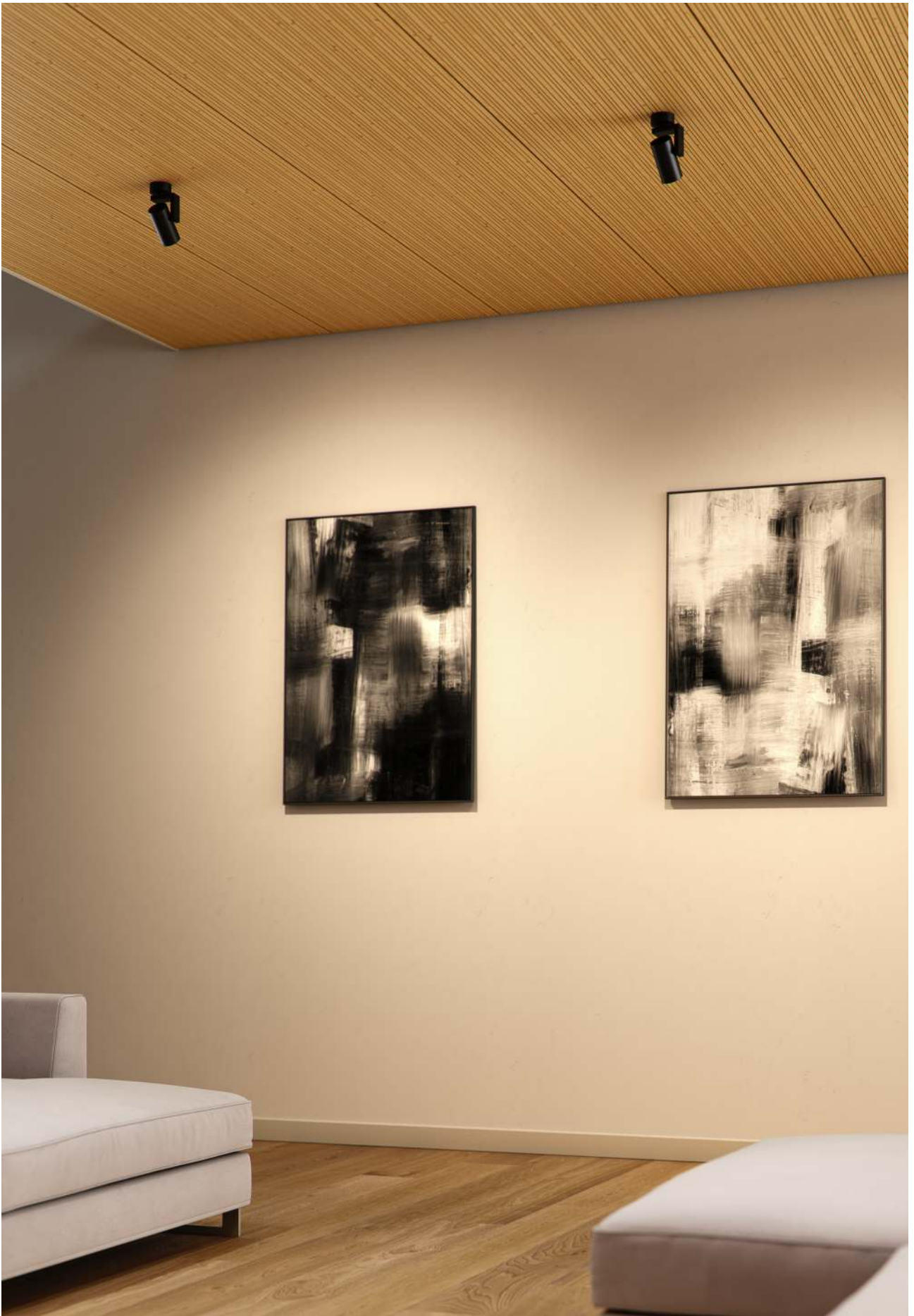

Volt r base

Volt sq base

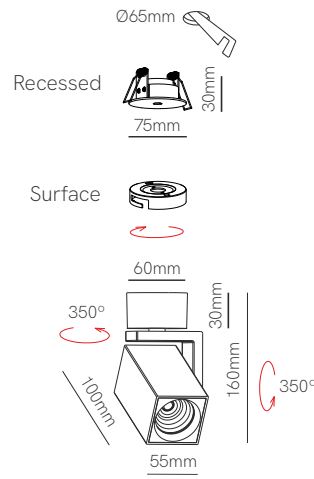
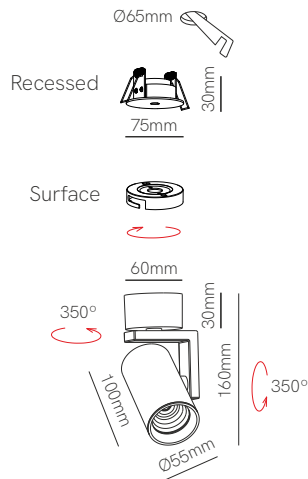

*Included surface base (mounted) and recessed base (not mounted).

Technical Information

Power	8W	8W
Installation	Surface / Recessed	Surface / Recessed
Color Temperature	Switch 2.700K / 3.200K / 4.000K	Switch 2.700K / 3.200K / 4.000K
Lumens	570 lm	570 lm
Material	Aluminium	Aluminium
Finishes	White / Black	White / Black
Code	<input type="radio"/> 5041 <input checked="" type="radio"/> 5042 <input checked="" type="radio"/> Custom RAL	<input type="checkbox"/> 5043 <input checked="" type="checkbox"/> 5044 <input checked="" type="checkbox"/> Custom RAL



ⓘ Consult delivery terms and conditions.

3 YEARS WARRANTY | 30.000 HOURS | → | IP 20 | 100/277 VAC | PF >0,9 | | 38° | IK06 | 50/60 Hz | +45°C / -20°C | CCT SWITCH | 1/20

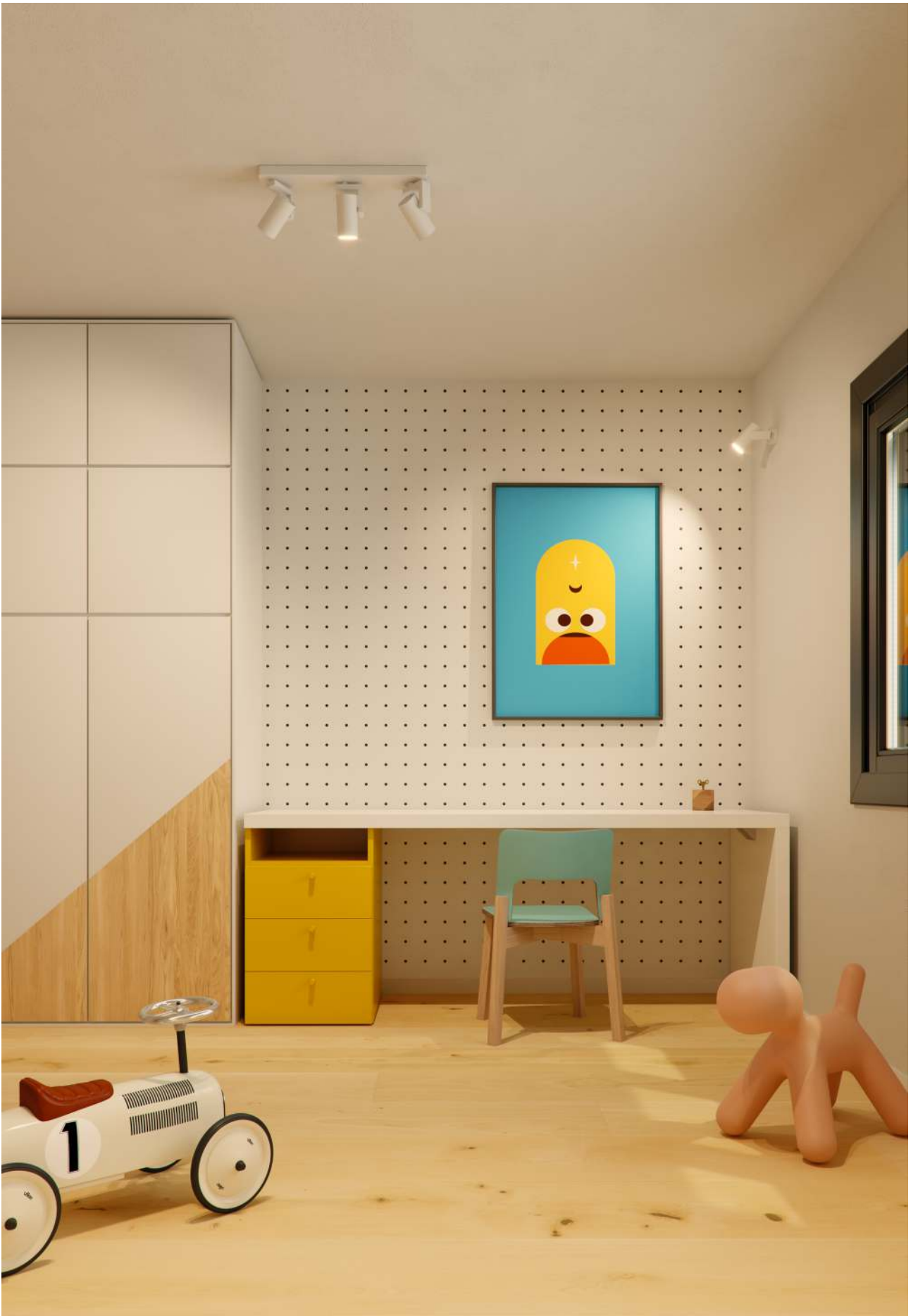

Volt r3 surface

Volt sq3 surface

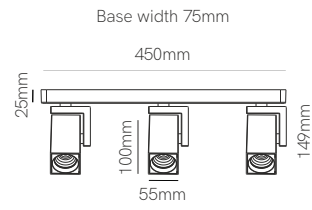
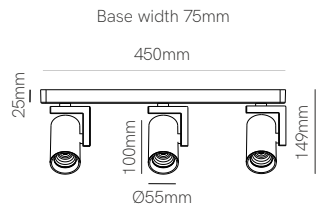

Technical Information

Power	24W	24W
Installation	Surface	Surface
Color Temperature	Switch 2.700K / 3.200K / 4.000K	Switch 2.700K / 3.200K / 4.000K
Lumens	1.700 lm	1.700 lm
Material	Aluminium	Aluminium
Finishes	White / Black	White / Black
Code	<input type="radio"/> 5045 <input checked="" type="radio"/> 5046 <input type="radio"/> Custom RAL	<input type="checkbox"/> 5047 <input checked="" type="checkbox"/> 5048 <input type="checkbox"/> Custom RAL



ⓘ Consult delivery terms and conditions.

3 YEARS WARRANTY | 30.000 HOURS | | IP 20 | 100/277 VAC | PF >0,9 | CRI ≥90 | 38° IK06 | 50/60 Hz | +45°C / -20°C | CCT SWITCH | 1/10

Volt r GU10 base

Volt sq GU10 base

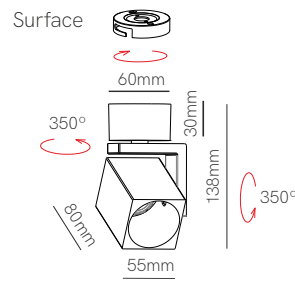
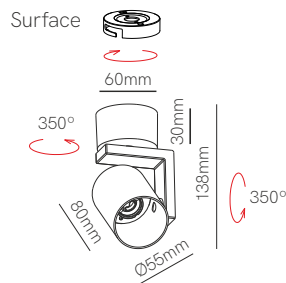
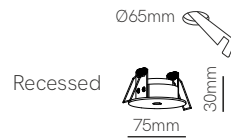
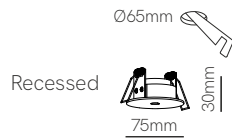

*Included surface base (mounted) and recessed base (not mounted).

Technical Information

Installation	Surface / Recessed	Surface / Recessed
Material	Aluminium	Aluminium
Finishes	White / Black	White / Black
Bulbholder	50mm GU10 (except Power bulb)	50mm GU10 (except Power bulb)
Code	<input type="radio"/> 5049 <input type="radio"/> 5050 <input checked="" type="radio"/> Custom RAL	<input type="checkbox"/> 5051 <input type="checkbox"/> 5052 <input checked="" type="checkbox"/> Custom RAL

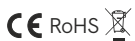

ⓘ Consult delivery terms and conditions.



Volt r3 GU10 surface

Volt sq3 GU10 surface

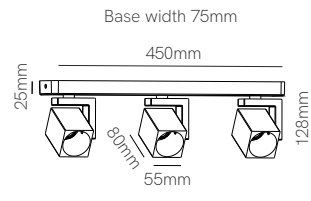
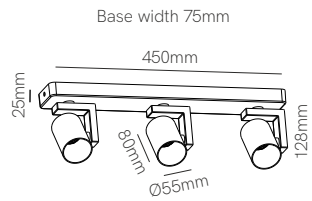

Technical Information

Installation	Surface	Surface
Material	Aluminium	Aluminium
Finishes	White / Black	White / Black
Bulbholder	50mm GU10 (except Power bulb)	50mm GU10 (except Power bulb)
Code	<input type="radio"/> 5053 <input type="radio"/> 5054 <input checked="" type="radio"/> Custom RAL	<input type="checkbox"/> 5055 <input type="checkbox"/> 5056 <input checked="" type="checkbox"/> Custom RAL



① Consult delivery terms and conditions.



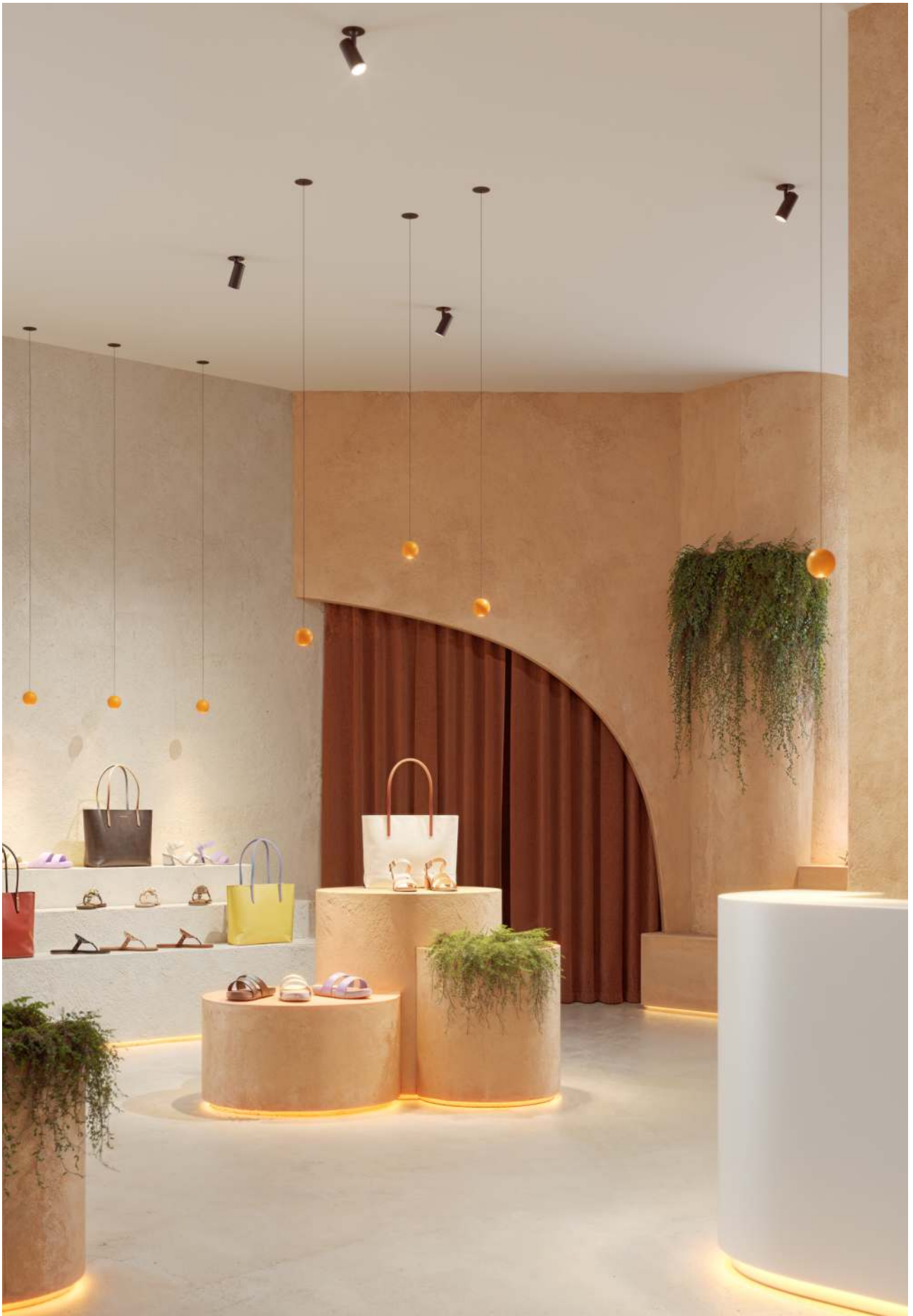

Piccolo base

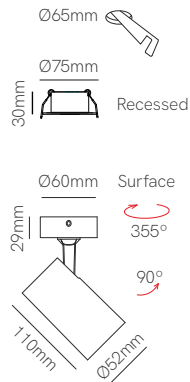

Technical Information

Power	9,5W
Installation	Surface / Recessed
Color Temperature	Switch 2.700K / 3.200K / 4.000K
Lumens	1.300 lm
Material	Aluminium
Finishes	White / Black

Code	<input type="radio"/> 4833-N <input type="radio"/> 4834-N <input checked="" type="radio"/> Custom RAL
------	---



ⓘ Consult delivery terms and conditions.
*Surface and recessed base included.

3 YEARS WARRANTY | 30.000 HOURS | IP 20 | 220/240 VAC | UGR <19 | PF >0,9 | CRI ≥90 | 15° / 38° / 60° | 50/60 Hz | +50°C / -20°C | CCT SWITCH | 1/20



Piccolo GU10 surface

Piccolo AR111 surface

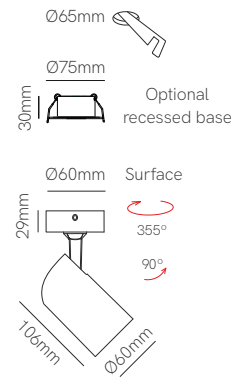
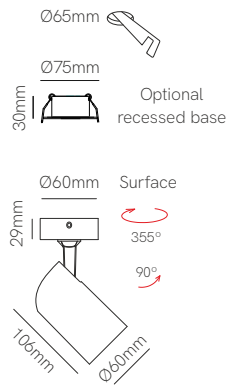

SURFACE

Technical Information

Installation	Surface / Recessed	Surface / Recessed
Material	Aluminium	Aluminium
Finishes	White / Black	White
Bulbholder	50mm GU10 (except Power bulb)	111mm GU10
Code	<input type="radio"/> 4050 <input type="radio"/> 4049 <input checked="" type="radio"/> Custom RAL	<input type="radio"/> 4433 <input checked="" type="radio"/> Custom RAL

Consult delivery terms and conditions.

Accessories



Recessed base (not included)

4835 4836



*GU10 bulbholder included.





▶ VIDEO



Crown base

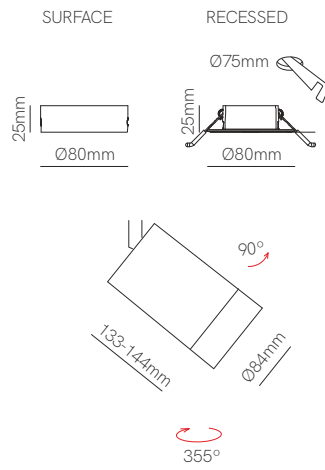

Technical Information

Power	25W
Installation	Surface / Recessed
Color Temperature	Switch 2.700K / 3.200K / 4.000K
Lumens	2.300 lm
Material	Aluminium and polycarbonate
Finishes	White / Black
Code	○ 5224 ● 5225



Includes surface and recessed base (not mounted).

3 YEARS WARRANTY | 25.000 HOURS | IP 20 | 220/240 VAC | UGR <19 | PF >0,9 | CRI ≥90 | 24° - 60° | 50/60 Hz | +40°C / -20°C | CCT SWITCH | 1/20



Mini Kora r surface

Kora r surface

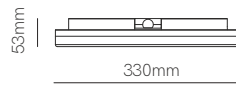
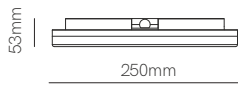

Technical Information

Power	20W	25W
Installation	Surface	Surface
Color Temperature	Switch 2.700K / 3.200K / 4.000K	Switch 2.700K / 3.200K / 4.000K
Lumens	2.400 lm	3.000 lm
Material	Polybutylene and Polycarbonate	Polybutylene and Polycarbonate
Finishes	White	White
Code	○ 4832	○ 4500-V2

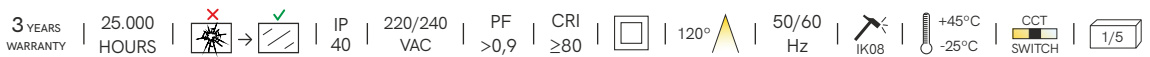



Mini Kora sq surface

Kora sq surface

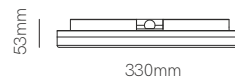
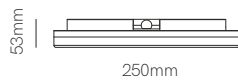

Technical Information

Power	20W	25W
Installation	Surface	Surface
Color Temperature	Switch 2.700K / 3.200K / 4.000K	Switch 2.700K / 3.200K / 4.000K
Lumens	2.400 lm	3.000 lm
Material	Polybutylene and Polycarbonate	Polybutylene and Polycarbonate
Finishes	White	White
Code	<input type="checkbox"/> 4831	<input type="checkbox"/> 4499-V2

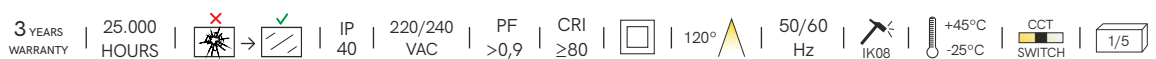



Casa Patio, Gran Canaria (Spain). Architecture: Room C Studio. Building contractor: Marcelasa S.L. Photography: David Rodriguez.

Nox surface

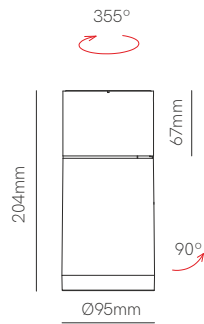

SURFACE

Technical Information

Power	30W
Installation	Surface
Color Temperature	Switch 2.700K / 3.200K / 4.000K
Lumens	2.460 lm
Material	Aluminium
Finishes	White / Black

Code	<input type="radio"/> 4241-N
	<input type="radio"/> 4242-N
	<input type="radio"/> Custom RAL

Consult delivery terms and conditions.

Accessories



Included with:
4241-N



Included with:
4241-N / 4242-N



3 YEARS WARRANTY |
 30.000 HOURS |
 |
 IP 20 |
 220/240 VAC |
 UGR <19 |
 PF >0,9 |
 CRI ≥94 |
 |
 15° / 24° / 40° |
 50/60 Hz |
 |
 +50°C / -20°C |
 |
 CCT SWITCH |
 |
 1/8



One surface

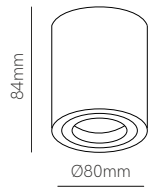

Zio surface

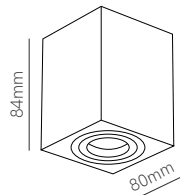

Avant r surface

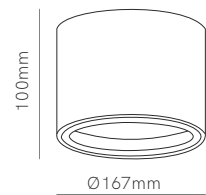

*GU10 Bulbholder included.

Technical Information

	One	Zio	Avant
Installation	Surface	Surface	Surface
Material	Aluminium	Aluminium	Aluminium
Finishes	White / Black	White / Black	White / Black
Bulbholder	50mm GU10 (except Power bulb)	50mm GU10 (except Power bulb)	111mm GU10
Code	<ul style="list-style-type: none"> ○ 4480 ● 4481 ① Custom RAL 	<ul style="list-style-type: none"> □ 4482 ■ 4483 ① Custom RAL 	<ul style="list-style-type: none"> ○ 4933 ● 4934 ① Custom RAL
	1/20	1/20	1/10



① Consult delivery terms and conditions.

