





Solar



Gam

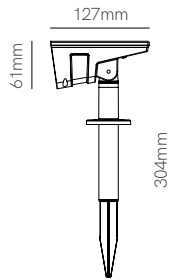

Technical Information

Power	0,7W
Installation	Floor
Color Temperature	Switch 2.700K / 3.200K / 4.000K
Lumens	85 lm
Material	ABS + PMMA
Finishes	Black
Code	■ 5178

CE RoHS

3 YEARS WARRANTY | 
 2 YEARS WARRANTY | 
 20.000 HOURS | 
 6-8 HOURS | 
 6-8H. | 
 1.800 mAh | 
 IP 54 | 
 CRI ≥80 | 
 270° | 
 IK02 | 
 +55°C / -10°C | 
 ON OFF | 
 CCT SWITCH | 
 1/50

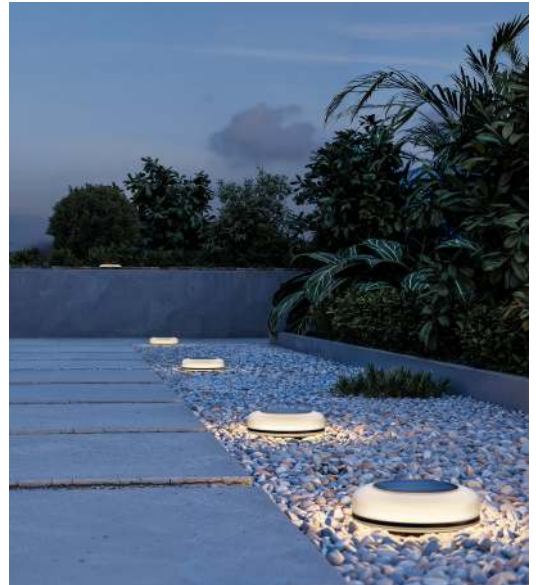

Twist

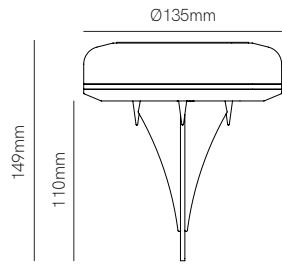

Technical Information

Power	1W
Installation	Floor
Color Temperature	Switch 2.700K / RGB
Lumens	20 lm
Material	ABS
Finishes	Black
Code	■ 5701

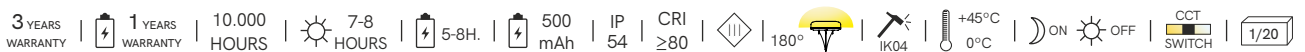

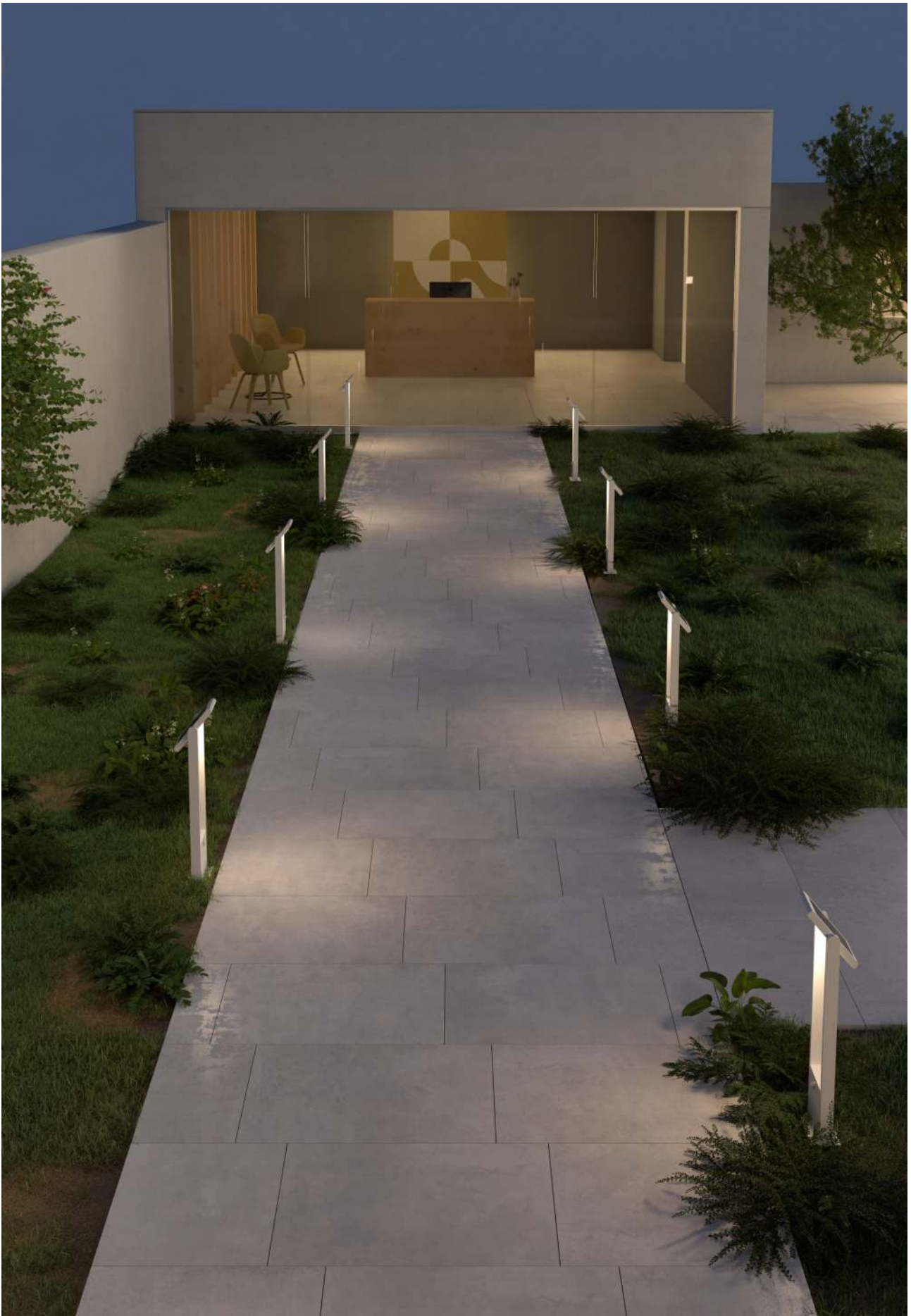

Popa

Popa XL

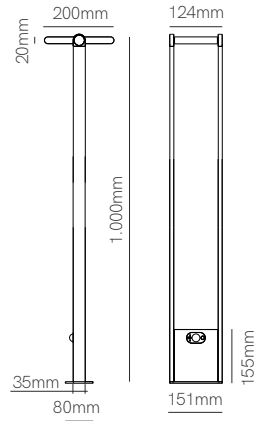
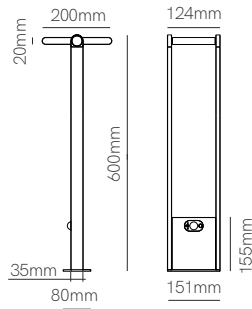

Technical Information

Power	1,6W	1,6W
Installation	Floor	Floor
Color Temperature	4.000K	4.000K
Lumens	150 lm	150 lm
Material	Aluminium	Aluminium
Finishes	White / Black	White / Black
Code	<input type="checkbox"/> 3882 <input checked="" type="checkbox"/> 3883	<input type="checkbox"/> 3884 <input checked="" type="checkbox"/> 3885



3 YEARS WARRANTY | 2 YEARS WARRANTY | 20.000 HOURS | 5-6 HOURS | 15% 10H. 100% 2-3H. | 2.200 mAh | IP 54 | CRI ≥80 | 120° | IK08 | +45°C -25°C | PIR SENSOR | ON OFF | 8 sec 8 min | 1/2



Proa

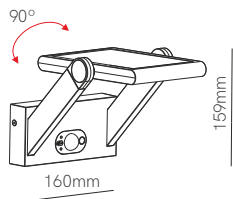

Technical Information

Power	1,6W
Installation	Surface
Color Temperature	4.000K
Lumens	150 lm
Material	Aluminium
Finishes	White / Black
Code	<input type="checkbox"/> 3531 <input checked="" type="checkbox"/> 3532



3 YEARS WARRANTY | 2 YEARS WARRANTY | 20.000 HOURS | 5-6 HOURS | 15% 10H. 100% 2-3H. | 2.200 mAh | IP 54 | CRI ≥80 | 120° | IK08 | +45°C -25°C | PIR SENSOR | ON OFF | 8 sec 8 min | 1/6



Egna

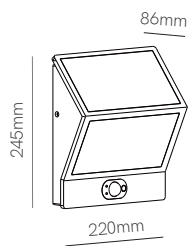

Technical Information

Power	3W
Installation	Surface
Color Temperature	4.000K
Lumens	250 lm
Material	Aluminium
Finishes	White / Black
Code	<input type="checkbox"/> 3587 <input checked="" type="checkbox"/> 3592



3 YEARS WARRANTY | 2 YEARS WARRANTY | 25.000 HOURS | 5-6 HOURS | 11% 20H. | 100% 2-3H. | 4.500 mAh | IP 54 | CRI ≥80 | 120° | IK08 | +45°C | -25°C | PIR SENSOR | ON OFF | 1/8



Iris

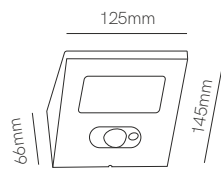

Technical Information

Power	2,5W
Installation	Surface
Color Temperature	4.000K
Lumens	174 lm
Material	Aluminium
Finishes	White / Black
Code	<input type="checkbox"/> 3496 <input type="checkbox"/> 3497

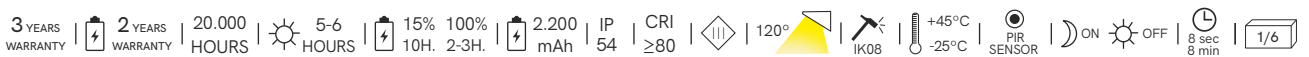

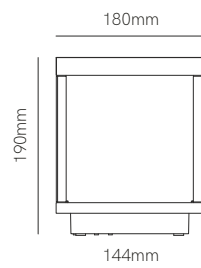

---

 Visor solar



---

 Technical Information

Power	3,5W
Installation	Portable
Color Temperature	3.000K
Lumens	460 lm
Material	Aluminium
Finishes	White / Black / Corten

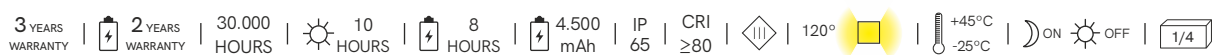
Code	<input type="checkbox"/> 4209
	<input type="checkbox"/> 4193
	<input type="checkbox"/> 4194





### Sky solar sensor

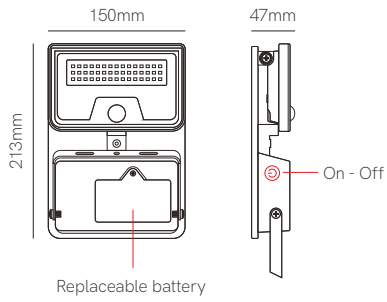

### Technical Information

Power	8W
Installation	Surface
Color Temperature	4.000K
Lumens	1.600 lm
Material	Polycarbonate
Finishes	White / Black
Code	<input type="checkbox"/> 5572 <input checked="" type="checkbox"/> 5573



3 YEARS WARRANTY | 2 YEARS WARRANTY | 30.000 HOURS | 9 HOURS | 10% 12H. 100% 2H. | 4.000 mAh | IP 54 | CRI ≥80 | 120° | 4-6m | PIR SENSOR | ON OFF | +45°C -20°C | 1/20